

**GENERAL INFORMATION**

**SCREW-BOLT+™**

High Performance Screw Anchor

**PRODUCT DESCRIPTION**

The Screw-Bolt+ anchor is a one piece, heavy duty screw anchor with a finished hex head or flat head (countersunk). Suitable base materials include normal-weight concrete, sand-lightweight concrete, concrete over steel deck, concrete masonry and solid clay brick. It is simple to install, easy to identify and fully removable. The patented thread design, designed for use with standard ANSI drill bits, reduces installation torque and enhances productivity. The steel threads along the anchor body tap into the hole during installation to provide keyed engagement and allow for reduced edge and spacing distances. The Screw-Bolt+ is available as bright zinc-plated or mechanically galvanized plating.

**GENERAL APPLICATIONS AND USES**

- Racking, shelving and material handling
- Support ledgers and sill plate attachments
- Barriers, guards and temporary supports
- Glazing and window attachments
- Retrofits, repairs and maintenance
- Fencing, railing and stair stringers
- Cracked and uncracked concrete
- Seismic and wind loading (SDC A - F)

**FEATURES AND BENEFITS**

- + Designed for standard ANSI tolerance drill bits
- + Patented thread design offers toughened threads for tapping high strength concrete
- + Low installation torque in concrete and masonry
- + Universal product for concrete and grouted/solid masonry
- + Ratchet teeth on underside of hex washer head lock against the fixture
- + Can be installed closer to a free edge than traditional expansion anchors
- + Fully removable and reinstallable in same hole (see www.DEWALT.com)
- + Fast installation with powered impact wrench, but can also be installed manually
- + Diameter, length and identifying marking stamped on head of each anchor
- + One-piece, finished head design

**APPROVALS AND LISTINGS**

- International Code Council, Evaluation Service (ICC-ES), ESR-3889 for concrete
- International Code Council, Evaluation Service (ICC-ES), ESR-4042 for masonry
- Code Compliant with the International Building Code/International Residential Code: 2021 IBC/IRC, 2018 IBC/IRC, 2015 IBC/IRC, and 2012 IBC/IRC
- Tested in accordance with ACI 355.2, ASTM E488 and ICC-ES AC193 for use in structural applications in concrete under the design provisions of ACI 318 (Strength Design Method)
- Evaluated and qualified by an accredited independent testing laboratory for recognition in cracked and uncracked concrete including seismic and wind loading (anchor Category 1)
- Evaluated and qualified by an accredited independent testing laboratory for sensitivity and reliability against brittle failure, e.g. hydrogen embrittlement

**GUIDE SPECIFICATIONS**

CSI Divisions: 03 16 00 - Concrete Anchors, 04 05 19.16 - Masonry Anchors and 05 05 19 - Post-Installed Concrete Anchors. Screw anchors shall be Screw-Bolt+ as supplied by DEWALT, Towson, MD. Anchors shall be installed in accordance with published instructions and the Authority Having Jurisdiction.

**MATERIAL SPECIFICATIONS**

Anchor component	Specification
Anchor Body and hex washer head	Case hardened carbon steel
Plating	Standard zinc plated version Zinc plating according to ASTM B633, SC1 Type III (Fe/Zn 5). Minimum plating requirements for Mild Service Condition
	Mechanically galvanized version Mechanically Galvanized Zinc plating according to ASTM B695, Class 55

**SECTION CONTENTS**

General Information..... 1  
 Installation Specifications ..... 2  
 Installation Instructions ..... 2  
 Performance Data (ASD) ..... 3  
 Strength Design Information ..... 10  
 Design Strength Tables (SD) ..... 16  
 Ordering Information ..... 18

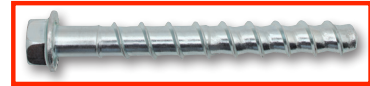

SCREW-BOLT+

**HEAD STYLES**

- Hex Washer Head or Flat Head

**ANCHOR MATERIALS**

- Zinc plated carbon steel or mechanically galvanized plating

**ANCHOR SIZE RANGE (TYP.)**

- 1/4" through 3/4" diameters

**SUITABLE BASE MATERIALS**

- Normal-weight concrete
- Lightweight concrete
- Concrete over steel deck
- Grouted Concrete Masonry (CMU)
- Brick Masonry



**MECHANICAL ANCHORS**  
**SCREW-BOLT+™**  
High Performance Screw Anchor

**INSTALLATION SPECIFICATIONS**

**Screw-Bolt+ Anchor Detail**

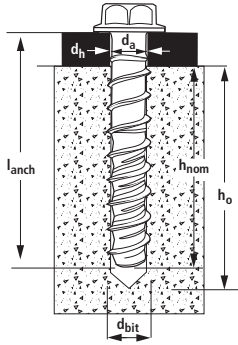

**Nomenclature**

- $d_a$  = Diameter of Anchor
- $d_{bit}$  = Diameter of Drill Bit
- $d_h$  = Diameter of Clearance Hole
- $h$  = Base Material Thickness.
- $h_{nom}$  = Minimum Nominal Embedment
- $h_o$  = Minimum Hole Depth

**Head Marking**

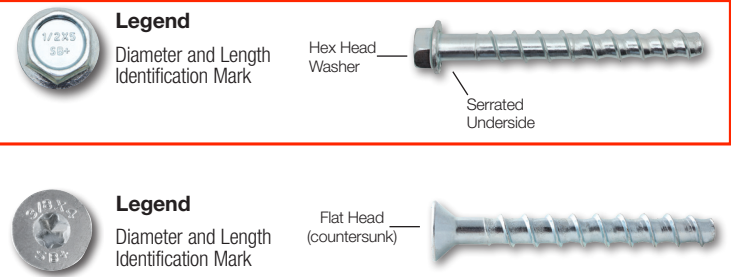

**Installation Specifications for Screw-Bolt+ in Concrete and Supplemental Information**

Anchor Property/ Setting Information	Notation	Units	Nominal Anchor Diameter (inch)				
			1/4	3/8	1/2	5/8	3/4
Anchor outside diameter	$d_a$ (d)	in. (mm)	0.250 (6.4)	0.375 (9.5)	0.500 (12.7)	0.625 (15.9)	0.750 (19.1)
Nominal drill bit diameter (ANSI)	$d_{bit}$	in.	1/4	3/8	1/2	5/8	3/4
Minimum diameter of hole clearance in fixture	$d_h$	in. (mm)	11/32 (8.7)	1/2 (12.7)	5/8 (15.9)	3/4 (19.1)	7/8 (22.2)
Minimum embedment depth <sup>1</sup>	$h_{nom}$	in. (mm)	1 (25)	1-1/2 (38)	1-3/4 (44)	2-1/2 (64)	2-1/2 (64)
Minimum hole depth	$h_o$	in. (mm)	$h_{nom} + 3/8$ (9.5)				
Minimum member thickness	$h_{min}$	in. (mm)	$h_{nom} + 2$ (51)				
Minimum edge distance	$c_{min}$	in. (mm)	1-1/2 (38)	1-1/2 (38)	1-3/4 (44)	1-3/4 (44)	1-3/4 (44)
Minimum spacing	$s_{min}$	in. (mm)	1-1/2 (38)	2 (51)	2-3/4 (70)	2-3/4 (70)	3 (76)
Max manual installation torque	$T_{inst,max}$	ft.-lb. (N-m)	19 (26)	25 (34)	45 (61)	60 (81)	70 (95)
Max impact wrench power (torque)	$T_{impact,max}$	ft.-lb. (N-m)	150 (203)	300 (407)	300 (407)	700 (950)	700 (950)
Hex Head	Impact wrench socket size	in.	7/16	9/16	3/4	15/16	1-1/8
	Maximum head height	in.	21/64	3/8	31/64	37/64	43/64
	Maximum washer diameter	-	37/64	3/4	1-1/16	1-1/8	1-13/32
Flat Head	Driver Size	in.	T-30	T-50	T-55	-	-
	Max head height	in.	13/64	21/64	11/32	-	-
	Max head diameter	in.	17/32	57/64	1	-	-
	Countersunk angle	in.	82	82	82	-	-
Effective tensile stress area (screw anchor body)	$A_{se}$	in <sup>2</sup>	0.045	0.094	0.176	0.274	0.399
Minimum ultimate strength	$f_{uta}$	psi	100,000	105,000	115,000	95,000	95,000
Minimum yield strength	$f_y$	psi	80,000	84,000	92,000	76,000	76,000

See Strength Design Information for installation specifications in strict accordance with ICC-ES ESR-3889.

1. See load capacities for Screw-Bolt+ in normal weight concrete for additional nominal embedment depths.

**INSTALLATION INSTRUCTIONS**

**Installation Instructions for Screw-Bolt+ (Hex Head Version Illustrated, Flat Head Version Not Shown)**

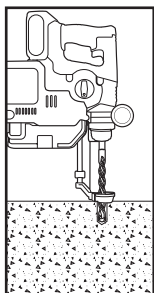

**Step 1**

Using the proper drill bit size, drill a hole into the base material to the required depth. The tolerances of the drill bit used should meet the requirements of ANSI standard B212.15

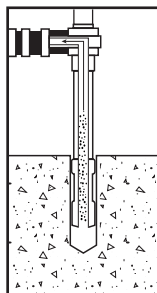

**Step 2**

Remove dust and debris from hole during drilling (e.g. dust extractor, hollow bit) or following drilling (e.g. suction, forced air) to extract loose particles created during drilling.

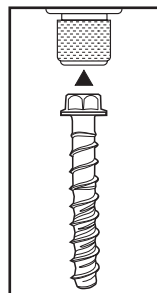

**Step 3**

Select a torque wrench or powered impact wrench and do not exceed the maximum torque,  $T_{inst,max}$  or  $T_{impact,max}$  respectively for the selected anchor diameter and embedment. Attach an appropriate sized hex socket/driver to the impact wrench. Mount the screw anchor head into the socket.

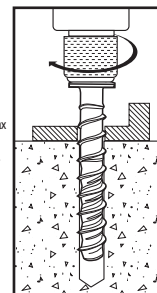

**Step 4**

Drive the anchor into the hole until the head of the anchor comes into contact with the fixture. The anchor must be snug after installation. Do not spin the hex socket off the anchor to disengage.

**PERFORMANCE DATA (ASD)**

**Ultimate Load Capacities for Screw-Bolt+ in Normal-Weight Concrete<sup>1,2</sup>**

Nominal Anchor Diameter in.	Minimum Nominal Embedment Depth in. (mm)	Minimum Concrete Compressive Strength									
		f'c = 2,500 psi (17.3 MPa)		f'c = 3,000 psi (20.7 MPa)		f'c = 4,000 psi (27.6 MPa)		f'c = 6,000 psi (41.4 MPa)		f'c = 8,000 psi (55.2 MPa)	
		Tension lbs (kN)	Shear lbs (kN)	Tension lbs (kN)	Shear lbs (kN)	Tension lbs (kN)	Shear lbs (kN)	Tension lbs (kN)	Shear lbs (kN)	Tension lbs (kN)	Shear lbs (kN)
1/4	1 (25)	1,325 (5.9)	1,660 (7.4)	1,400 (6.2)	1,755 (7.8)	1,530 (6.8)	1,910 (8.5)	1,725 (7.7)	2,080 (9.3)	1,725 (7.7)	2,080 (9.3)
	1-5/8 (41)	2,835 (12.6)	1,660 (7.4)	2,995 (13.3)	1,755 (7.8)	3,265 (14.5)	1,910 (8.5)	3,265 (14.5)	2,080 (9.3)	3,265 (14.5)	2,080 (9.3)
	2-1/2 (64)	3,650 (16.2)	2,025 (9.0)	3,855 (17.1)	2,140 (9.5)	4,200 (18.7)	2,335 (10.4)	4,270 (19.0)	2,545 (11.3)	4,270 (19.0)	2,545 (11.3)
3/8	1-1/2 (38)	2,630 (11.7)	3,550 (15.8)	2,880 (12.8)	3,890 (17.3)	3,330 (14.8)	4,490 (20.0)	4,075 (18.1)	5,500 (24.5)	4,075 (18.1)	6,355 (28.3)
	2 (51)	3,670 (16.3)	4,320 (19.2)	4,020 (17.9)	4,735 (21.1)	4,645 (20.7)	5,465 (24.3)	4,725 (21.0)	6,345 (28.2)	5,455 (24.3)	6,345 (28.2)
	2-1/2 (64)	5,175 (23.0)	4,320 (19.2)	5,670 (25.2)	4,740 (21.1)	6,410 (28.5)	5,460 (24.3)	6,456 (28.7)	6,340 (28.2)	7,420 (33.0)	6,340 (28.2)
	3-1/4 (83)	7,420 (33.0)	6,325 (28.1)	8,130 (36.2)	6,930 (30.8)	9,065 (40.3)	8,000 (35.6)	9,065 (40.3)	8,565 (38.1)	10,350 (46.0)	8,565 (38.1)
	4-1/2 (114)	10,905 (48.5)	6,325 (28.1)	11,945 (53.1)	6,930 (30.8)	13,795 (61.4)	8,000 (35.6)	15,075 (67.1)	8,565 (38.1)	15,075 (67.1)	8,565 (38.1)
1/2	1-3/4 (44)	2,840 (12.6)	5,985 (26.6)	3,115 (13.9)	6,555 (29.2)	3,595 (16.0)	7,570 (33.7)	4,400 (19.6)	9,270 (41.2)	4,400 (19.6)	10,705 (47.6)
	2-1/2 (64)	6,680 (29.7)	8,035 (35.7)	7,320 (32.6)	8,800 (39.1)	8,450 (37.6)	10,160 (45.2)	8,450 (37.6)	11,545 (51.4)	8,450 (37.6)	11,545 (51.4)
	3 (76)	8,560 (38.0)	8,040 (35.8)	9,375 (41.7)	8,800 (39.1)	10,750 (47.8)	10,160 (45.2)	10,750 (47.8)	11,540 (51.3)	10,750 (47.8)	11,540 (51.3)
	4-1/4 (108)	13,260 (59.0)	9,395 (41.8)	14,525 (64.6)	10,290 (45.8)	16,480 (73.3)	11,885 (52.9)	16,480 (73.3)	13,520 (60.1)	16,480 (73.3)	13,520 (60.1)
	5-1/2 (140)	15,730 (70.0)	9,395 (41.8)	17,235 (76.7)	10,290 (45.8)	19,900 (88.5)	11,885 (52.9)	21,310 (94.8)	13,520 (60.1)	21,310 (94.8)	13,520 (60.1)
5/8	2-1/2 (64)	5,735 (25.5)	10,615 (47.2)	6,285 (28.0)	11,630 (51.7)	7,255 (32.3)	13,425 (59.7)	8,885 (39.5)	16,445 (73.2)	8,885 (39.5)	17,170 (76.4)
	3-1/4 (83)	9,755 (43.4)	12,065 (53.7)	10,685 (47.5)	13,220 (58.8)	12,340 (54.9)	15,265 (67.9)	12,340 (54.9)	17,170 (76.4)	12,340 (54.9)	17,170 (76.4)
	4 (102)	11,770 (52.4)	12,060 (53.6)	12,890 (57.3)	13,220 (58.8)	14,880 (66.2)	15,260 (67.9)	15,325 (68.2)	17,180 (76.4)	16,600 (73.8)	17,180 (76.4)
	5 (127)	14,455 (64.3)	13,675 (60.8)	15,830 (70.4)	14,980 (66.6)	18,280 (81.3)	17,295 (76.9)	19,295 (85.8)	19,485 (86.7)	22,280 (99.1)	19,485 (86.7)
	6-1/4 (159)	20,520 (91.3)	13,675 (60.8)	22,475 (100.0)	14,980 (66.6)	25,955 (115.5)	17,295 (76.9)	31,785 (141.4)	19,485 (86.7)	31,785 (141.4)	19,485 (86.7)
3/4	2-1/2 (64)	6,035 (26.8)	11,615 (51.7)	6,610 (29.4)	12,725 (56.6)	7,635 (34.0)	14,690 (65.3)	9,350 (41.6)	17,995 (80.0)	9,350 (41.6)	20,775 (92.4)
	4-1/4 (108)	11,900 (52.9)	17,055 (75.9)	13,035 (58.0)	18,685 (83.1)	15,050 (66.9)	21,575 (96.0)	17,745 (78.9)	24,270 (108.0)	20,490 (91.1)	24,270 (108.0)
	5 (127)	19,020 (84.6)	17,055 (75.9)	20,835 (92.7)	18,685 (83.1)	24,055 (107.0)	21,575 (96.0)	29,460 (131.0)	24,270 (108.0)	29,460 (131.0)	24,270 (108.0)
	6-1/4 (159)	20,495 (91.2)	17,055 (75.9)	22,450 (99.9)	18,685 (83.1)	25,920 (115.3)	21,575 (96.0)	31,750 (141.2)	24,270 (108.0)	31,750 (141.2)	24,270 (108.0)

1. Tabulated load values are for anchors installed in uncracked concrete with no edge or spacing considerations. Concrete compressive strength must be at the specified minimum at the time of installation.
2. Ultimate load capacities must be reduced by a minimum safety factor of 4.0 or greater to determine allowable working load.

**Allowable Load Capacities for Screw-Bolt+ in Normal-Weight Concrete**<sup>1,2,3,4,5</sup>



Nominal Anchor Diameter in.	Minimum Nominal Embedment Depth in. (mm)	Minimum Concrete Compressive Strength									
		f'c = 2,500 psi (17.3 MPa)		f'c = 3,000 psi (20.7 MPa)		f'c = 4,000 psi (27.6 MPa)		f'c = 6,000 psi (41.4 MPa)		f'c = 8,000 psi (55.2 MPa)	
		Tension lbs (kN)	Shear lbs (kN)	Tension lbs (kN)	Shear lbs (kN)	Tension lbs (kN)	Shear lbs (kN)	Tension lbs (kN)	Shear lbs (kN)	Tension lbs (kN)	Shear lbs (kN)
1/4	1 (25)	330 (1.5)	415 (1.8)	350 (1.6)	440 (2.0)	385 (1.7)	480 (2.1)	430 (1.9)	520 (2.3)	430 (1.9)	520 (2.3)
	1-5/8 (41)	710 (3.2)	415 (1.8)	750 (3.3)	440 (2.0)	815 (3.6)	480 (2.1)	815 (3.6)	520 (2.3)	815 (3.6)	520 (2.3)
	2-1/2 (64)	915 (4.1)	505 (2.2)	965 (4.3)	535 (2.4)	1,050 (4.7)	585 (2.6)	1,070 (4.8)	635 (2.8)	1,070 (4.8)	635 (2.8)
3/8	1-1/2 (38)	660 (2.9)	890 (4.0)	720 (3.2)	975 (4.3)	835 (3.7)	1,125 (5.0)	1,020 (4.5)	1,375 (6.1)	1,020 (4.5)	1,590 (7.1)
	2 (51)	920 (4.1)	1,080 (4.8)	1,005 (4.5)	1,185 (5.3)	1,160 (5.2)	1,365 (6.1)	1,180 (5.2)	1,585 (7.1)	1,365 (6.1)	1,585 (7.1)
	2-1/2 (64)	1,295 (5.8)	1,080 (4.8)	1,415 (6.3)	1,185 (5.3)	1,600 (7.1)	1,365 (6.1)	1,615 (7.2)	1,585 (7.1)	1,855 (8.3)	1,585 (7.1)
	3-1/4 (83)	1,855 (8.3)	1,580 (7.0)	2,035 (9.1)	1,735 (7.7)	2,265 (10.1)	2,000 (8.9)	2,265 (10.1)	2,140 (9.5)	2,590 (11.5)	2,140 (9.5)
	4-1/2 (114)	2,725 (12.1)	1,580 (7.0)	2,985 (13.3)	1,735 (7.7)	3,450 (15.3)	2,000 (8.9)	3,770 (16.8)	2,140 (9.5)	3,770 (16.8)	2,140 (9.5)
1/2	1-3/4 (44)	710 (3.2)	1,495 (6.7)	780 (3.5)	1,640 (7.3)	900 (4.0)	1,895 (8.4)	1,100 (4.9)	2,320 (10.3)	1,100 (4.9)	2,675 (11.9)
	2-1/2 (64)	1,670 (7.4)	2,010 (8.9)	1,830 (8.1)	2,200 (9.8)	2,115 (9.4)	2,540 (11.3)	2,115 (9.4)	2,885 (12.8)	2,115 (9.4)	2,885 (12.8)
	3 (76)	2,140 (9.5)	2,010 (8.9)	2,345 (10.4)	2,200 (9.8)	2,690 (11.9)	2,540 (11.3)	2,690 (11.9)	2,885 (12.8)	2,690 (11.9)	2,885 (12.8)
	4-1/4 (108)	3,315 (14.7)	2,350 (10.5)	3,630 (16.1)	2,575 (11.5)	4,120 (18.3)	2,970 (13.2)	4,120 (18.3)	3,380 (15.0)	4,120 (18.3)	3,380 (15.0)
	5-1/2 (140)	3,935 (17.5)	2,350 (10.5)	4,310 (19.2)	2,575 (11.5)	4,975 (22.1)	2,970 (13.2)	5,330 (23.7)	3,380 (15.0)	5,330 (23.7)	3,380 (15.0)
5/8	2-1/2 (64)	1,435 (6.4)	2,655 (11.8)	1,570 (7.0)	2,910 (12.9)	1,815 (8.1)	3,355 (14.9)	2,220 (9.9)	4,110 (18.3)	2,220 (9.9)	4,295 (19.1)
	3-1/4 (83)	2,440 (10.9)	3,015 (13.4)	2,670 (11.9)	3,305 (14.7)	3,085 (13.7)	3,815 (17.0)	3,085 (13.7)	4,295 (19.1)	3,085 (13.7)	4,295 (19.1)
	4 (102)	2,940 (13.1)	3,015 (13.4)	3,225 (14.3)	3,305 (14.7)	3,720 (16.5)	3,815 (16.9)	3,830 (17.0)	4,295 (19.1)	4,150 (18.5)	4,295 (19.1)
	5 (127)	3,615 (16.1)	3,420 (15.2)	3,960 (17.6)	3,745 (16.7)	4,570 (20.3)	4,325 (19.2)	4,825 (21.5)	4,870 (21.7)	5,570 (24.8)	4,870 (21.7)
	6-1/4 (159)	5,130 (22.8)	3,420 (15.2)	5,620 (25.0)	3,745 (16.7)	6,490 (28.9)	4,325 (19.2)	7,945 (35.3)	4,870 (21.7)	7,945 (35.3)	4,870 (21.7)
3/4	2-1/2 (64)	1,510 (6.7)	2,905 (12.9)	1,655 (7.4)	3,180 (14.1)	1,910 (8.5)	3,675 (16.3)	2,340 (10.4)	4,500 (20.0)	2,340 (10.4)	5,195 (23.1)
	4-1/4 (108)	2,975 (13.2)	4,265 (19.0)	3,260 (14.5)	4,670 (20.8)	3,765 (16.7)	5,395 (24.0)	4,435 (19.7)	6,070 (27.0)	5,125 (22.8)	6,070 (27.0)
	5 (127)	4,755 (21.2)	4,265 (19.0)	5,210 (23.2)	4,670 (20.8)	6,015 (26.8)	5,395 (24.0)	7,365 (32.8)	6,070 (27.0)	7,365 (32.8)	6,070 (27.0)
	6-1/4 (159)	5,125 (22.8)	4,265 (19.0)	5,615 (25.0)	4,670 (20.8)	6,480 (28.8)	5,395 (24.0)	7,940 (35.3)	6,070 (27.0)	7,940 (35.3)	6,070 (27.0)

1. Tabulated load values are for anchors installed in uncracked concrete. Concrete compressive strength must be at the specified minimum at the time of installation.
2. Allowable load capacities are calculated using an applied safety factor of 4.0 to average ultimate load capacities.
3. Allowable load capacities must be multiplied by reduction factors when anchor spacing or edge distances are less than critical distances.
4. Linear interpolation may be used to determine allowable loads for intermediate embedments and compressive strengths.
5. For lightweight concrete multiply tabulated allowable load values by a reduction factor of 0.60.

**MECHANICAL ANCHORS**

**SCREW-BOLT+™**  
High Performance Screw Anchor

**LOAD ADJUSTMENT FACTORS FOR NORMAL-WEIGHT CONCRETE**

**Edge Distance Reduction Factors - Tension (F<sub>NC</sub>)**

Diameter (in)	1/4			3/8				1/2					5/8				3/4					
Nominal Embedment h <sub>nom</sub> (in)	1	1-5/8	2-1/2	1-1/2	2	2-1/2	3-1/4	4-1/2	1-3/4	2-1/2	3	4-1/4	5-1/2	2-1/2	3-1/4	4	5	6-1/4	2-1/2	4-1/4	5	6-1/4
Min. Edge Distance c <sub>min</sub> (in)	1-1/2	1-1/2	1-1/2	1-1/2	1-1/2	1-1/2	1-1/2	1-1/2	1-3/4	1-3/4	1-3/4	1-3/4	1-3/4	1-3/4	1-3/4	1-3/4	1-3/4	1-3/4	1-3/4	1-3/4	1-3/4	1-3/4
1-1/2	1.00	0.77	0.64	0.85	0.74	0.67	0.59	0.55	-	-	-	-	-	-	-	-	-	-	-	-	-	-
1-3/4	1.00	0.83	0.67	0.93	0.79	0.71	0.62	0.57	0.87	0.71	0.65	0.58	0.54	0.73	0.65	0.60	0.56	0.53	0.73	0.59	0.56	0.53
2	1.00	0.88	0.71	1.00	0.84	0.76	0.65	0.59	0.94	0.76	0.68	0.60	0.56	0.78	0.68	0.63	0.58	0.54	0.78	0.61	0.58	0.54
2-1/4	1.00	0.94	0.75	1.00	0.89	0.80	0.68	0.61	1.00	0.80	0.71	0.63	0.57	0.82	0.71	0.65	0.60	0.56	0.82	0.63	0.60	0.56
2-1/2	1.00	1.00	0.78	1.00	0.95	0.84	0.71	0.63	1.00	0.84	0.74	0.65	0.59	0.87	0.75	0.68	0.62	0.57	0.87	0.66	0.62	0.57
2-3/4	1.00	1.00	0.82	1.00	1.00	0.88	0.74	0.65	1.00	0.88	0.77	0.67	0.61	0.91	0.78	0.70	0.64	0.59	0.91	0.68	0.64	0.59
3	1.00	1.00	0.86	1.00	1.00	0.92	0.77	0.67	1.00	0.92	0.81	0.69	0.62	0.96	0.81	0.73	0.66	0.60	0.96	0.70	0.66	0.60
3-1/2	1.00	1.00	0.93	1.00	1.00	1.00	0.83	0.71	1.00	1.00	0.87	0.74	0.65	1.00	0.87	0.78	0.69	0.63	1.00	0.75	0.69	0.63
4	1.00	1.00	1.00	1.00	1.00	1.00	0.88	0.75	1.00	1.00	0.94	0.78	0.69	1.00	0.94	0.83	0.73	0.66	1.00	0.79	0.73	0.66
4-1/2	1.00	1.00	1.00	1.00	1.00	1.00	0.94	0.79	1.00	1.00	1.00	0.82	0.72	1.00	1.00	0.88	0.77	0.69	1.00	0.84	0.77	0.69
5	1.00	1.00	1.00	1.00	1.00	1.00	1.00	0.84	1.00	1.00	1.00	0.87	0.75	1.00	1.00	0.93	0.81	0.72	1.00	0.89	0.81	0.72
5-1/2	1.00	1.00	1.00	1.00	1.00	1.00	1.00	0.88	1.00	1.00	1.00	0.91	0.79	1.00	1.00	0.98	0.85	0.75	1.00	0.93	0.85	0.75
6	1.00	1.00	1.00	1.00	1.00	1.00	1.00	0.92	1.00	1.00	1.00	0.96	0.82	1.00	1.00	1.00	0.89	0.78	1.00	0.98	0.89	0.78
6-1/2	1.00	1.00	1.00	1.00	1.00	1.00	1.00	0.96	1.00	1.00	1.00	1.00	0.85	1.00	1.00	1.00	0.92	0.81	1.00	1.00	0.92	0.81
7	1.00	1.00	1.00	1.00	1.00	1.00	1.00	1.00	1.00	1.00	1.00	1.00	0.88	1.00	1.00	1.00	0.96	0.84	1.00	1.00	0.96	0.84
7-1/2	1.00	1.00	1.00	1.00	1.00	1.00	1.00	1.00	1.00	1.00	1.00	1.00	0.92	1.00	1.00	1.00	1.00	0.87	1.00	1.00	1.00	0.87
8	1.00	1.00	1.00	1.00	1.00	1.00	1.00	1.00	1.00	1.00	1.00	1.00	0.95	1.00	1.00	1.00	1.00	0.90	1.00	1.00	1.00	0.90
8-1/2	1.00	1.00	1.00	1.00	1.00	1.00	1.00	1.00	1.00	1.00	1.00	1.00	0.98	1.00	1.00	1.00	1.00	0.93	1.00	1.00	1.00	0.93
9	1.00	1.00	1.00	1.00	1.00	1.00	1.00	1.00	1.00	1.00	1.00	1.00	1.00	1.00	1.00	1.00	1.00	0.96	1.00	1.00	1.00	0.96
9-1/2	1.00	1.00	1.00	1.00	1.00	1.00	1.00	1.00	1.00	1.00	1.00	1.00	1.00	1.00	1.00	1.00	1.00	0.99	1.00	1.00	1.00	0.99
10	1.00	1.00	1.00	1.00	1.00	1.00	1.00	1.00	1.00	1.00	1.00	1.00	1.00	1.00	1.00	1.00	1.00	1.00	1.00	1.00	1.00	1.00

**Spacing Reduction Factors - Tension (F<sub>NS</sub>)**

Diameter (in)	1/4			3/8				1/2					5/8				3/4					
Nominal Embedment h <sub>nom</sub> (in)	1	1-5/8	2-1/2	1-1/2	2	2-1/2	3-1/4	4-1/2	1-3/4	2-1/2	3	4-1/4	5-1/2	2-1/2	3-1/4	4	5	6-1/4	2-1/2	4-1/4	5	6-1/4
Minimum Spacing s <sub>min</sub> (in)	1-1/2	1-1/2	1-1/2	2	2	2	2	2	2-3/4	2-3/4	2-3/4	2-3/4	2-3/4	2-3/4	2-3/4	2-3/4	2-3/4	2-3/4	3	3	3	3
1-1/2	0.89	0.73	0.66	-	-	-	-	-	-	-	-	-	-	-	-	-	-	-	-	-	-	-
1-3/4	0.94	0.77	0.68	-	-	-	-	-	-	-	-	-	-	-	-	-	-	-	-	-	-	-
2	1.00	0.80	0.70	0.88	0.77	0.71	0.67	0.63	-	-	-	-	-	-	-	-	-	-	-	-	-	-
2-1/4	1.00	0.83	0.72	0.93	0.80	0.74	0.69	0.64	-	-	-	-	-	-	-	-	-	-	-	-	-	-
2-1/2	1.00	0.86	0.74	0.97	0.83	0.76	0.70	0.65	-	-	-	-	-	-	-	-	-	-	-	-	-	-
2-3/4	1.00	0.89	0.76	1.00	0.86	0.78	0.72	0.66	0.92	0.78	0.74	0.67	0.64	0.80	0.73	0.69	0.65	0.63	-	-	-	-
3	1.00	0.92	0.78	1.00	0.89	0.80	0.74	0.67	0.95	0.80	0.75	0.68	0.65	0.83	0.74	0.70	0.66	0.64	0.83	0.69	0.66	0.64
3-1/2	1.00	0.99	0.82	1.00	0.94	0.85	0.77	0.70	1.00	0.85	0.79	0.71	0.67	0.88	0.78	0.73	0.68	0.65	0.88	0.71	0.68	0.65
4	1.00	1.00	0.86	1.00	1.00	0.89	0.80	0.72	1.00	0.89	0.82	0.73	0.68	0.92	0.81	0.75	0.70	0.67	0.93	0.74	0.71	0.67
4-1/2	1.00	1.00	0.90	1.00	1.00	0.93	0.83	0.74	1.00	0.93	0.86	0.75	0.70	0.97	0.85	0.78	0.72	0.68	0.97	0.76	0.73	0.69
5	1.00	1.00	0.94	1.00	1.00	0.98	0.86	0.76	1.00	0.98	0.89	0.78	0.72	1.00	0.88	0.81	0.75	0.70	1.00	0.79	0.75	0.70
5-1/2	1.00	1.00	0.97	1.00	1.00	1.00	0.89	0.78	1.00	1.00	0.93	0.80	0.74	1.00	0.92	0.83	0.77	0.72	1.00	0.81	0.77	0.72
6	1.00	1.00	1.00	1.00	1.00	1.00	0.93	0.81	1.00	1.00	0.96	0.82	0.75	1.00	0.95	0.86	0.79	0.73	1.00	0.84	0.79	0.73
6-1/2	1.00	1.00	1.00	1.00	1.00	1.00	0.96	0.83	1.00	1.00	1.00	0.85	0.77	1.00	0.98	0.89	0.81	0.75	1.00	0.86	0.81	0.75
7	1.00	1.00	1.00	1.00	1.00	1.00	0.99	0.85	1.00	1.00	1.00	0.87	0.79	1.00	1.00	0.91	0.83	0.76	1.00	0.89	0.83	0.77
7-1/2	1.00	1.00	1.00	1.00	1.00	1.00	1.00	0.87	1.00	1.00	1.00	0.90	0.81	1.00	1.00	0.94	0.85	0.78	1.00	0.91	0.85	0.78
8	1.00	1.00	1.00	1.00	1.00	1.00	1.00	0.90	1.00	1.00	1.00	0.92	0.83	1.00	1.00	0.97	0.87	0.80	1.00	0.94	0.87	0.80
8-1/2	1.00	1.00	1.00	1.00	1.00	1.00	1.00	0.92	1.00	1.00	1.00	0.94	0.84	1.00	1.00	0.99	0.89	0.81	1.00	0.96	0.89	0.81
9	1.00	1.00	1.00	1.00	1.00	1.00	1.00	0.94	1.00	1.00	1.00	0.97	0.86	1.00	1.00	1.00	0.91	0.83	1.00	0.99	0.91	0.83
9-1/2	1.00	1.00	1.00	1.00	1.00	1.00	1.00	0.96	1.00	1.00	1.00	0.99	0.88	1.00	1.00	1.00	0.93	0.84	1.00	1.00	0.93	0.85
10	1.00	1.00	1.00	1.00	1.00	1.00	1.00	0.98	1.00	1.00	1.00	1.00	0.90	1.00	1.00	1.00	0.95	0.86	1.00	1.00	0.95	0.86
10-1/2	1.00	1.00	1.00	1.00	1.00	1.00	1.00	1.00	1.00	1.00	1.00	1.00	0.91	1.00	1.00	1.00	0.97	0.88	1.00	1.00	0.97	0.88
11	1.00	1.00	1.00	1.00	1.00	1.00	1.00	1.00	1.00	1.00	1.00	1.00	0.93	1.00	1.00	1.00	0.99	0.89	1.00	1.00	0.99	0.89
11-1/2	1.00	1.00	1.00	1.00	1.00	1.00	1.00	1.00	1.00	1.00	1.00	1.00	0.95	1.00	1.00	1.00	1.00	0.91	1.00	1.00	1.00	0.91
12	1.00	1.00	1.00	1.00	1.00	1.00	1.00	1.00	1.00	1.00	1.00	1.00	0.97	1.00	1.00	1.00	1.00	0.92	1.00	1.00	1.00	0.93
13	1.00	1.00	1.00	1.00	1.00	1.00	1.00	1.00	1.00	1.00	1.00	1.00	1.00	1.00	1.00	1.00	1.00	0.96	1.00	1.00	1.00	0.96
14	1.00	1.00	1.00	1.00	1.00	1.00	1.00	1.00	1.00	1.00	1.00	1.00	1.00	1.00	1.00	1.00	1.00	0.99	1.00	1.00	1.00	0.99
15	1.00	1.00	1.00	1.00	1.00	1.00	1.00	1.00	1.00	1.00	1.00	1.00	1.00	1.00	1.00	1.00	1.00	1.00	1.00	1.00	1.00	1.00

**MECHANICAL ANCHORS**

**SCREW-BOLT+**  
High Performance Screw Anchor

**Edge Distance Reduction Factors - Shear (F<sub>VC</sub>)**

Diameter (in)	1/4			3/8					1/2					5/8					3/4				
	Nominal Embedment h <sub>nom</sub> (in)	1	1-5/8	2-1/2	1-1/2	2	2-1/2	3-1/4	4-1/2	1-3/4	2-1/2	3	4-1/4	5-1/2	2-1/2	3-1/4	4	5	6-1/4	2-1/2	4-1/4	5	6-1/4
Min. Edge Distance C <sub>min</sub> (in)	1-1/2	1-1/2	1-1/2	1-1/2	1-1/2	1-1/2	1-1/2	1-1/2	1-3/4	1-3/4	1-3/4	1-3/4	1-3/4	1-3/4	1-3/4	1-3/4	1-3/4	1-3/4	1-3/4	1-3/4	1-3/4	1-3/4	1-3/4
Edge Distance (inches)	1-1/2	0.58	0.63	0.59	0.40	0.37	0.39	0.31	0.32	-	-	-	-	-	-	-	-	-	-	-	-	-	-
	1-3/4	0.68	0.73	0.69	0.46	0.43	0.45	0.36	0.38	0.35	0.31	0.36	0.30	0.31	0.27	0.26	0.32	0.25	0.26	0.26	0.22	0.22	0.23
	2	0.78	0.84	0.78	0.53	0.49	0.52	0.41	0.43	0.41	0.35	0.41	0.35	0.36	0.30	0.29	0.37	0.29	0.30	0.30	0.25	0.26	0.27
	2-1/4	0.87	0.94	0.88	0.59	0.55	0.58	0.46	0.48	0.46	0.40	0.46	0.39	0.40	0.34	0.33	0.41	0.32	0.33	0.33	0.28	0.29	0.30
	2-1/2	0.97	1.00	0.98	0.66	0.61	0.64	0.51	0.54	0.51	0.44	0.51	0.43	0.45	0.38	0.36	0.46	0.36	0.37	0.37	0.31	0.32	0.33
	2-3/4	1.00	1.00	1.00	0.73	0.67	0.71	0.56	0.59	0.56	0.49	0.56	0.48	0.49	0.42	0.40	0.51	0.40	0.41	0.41	0.34	0.35	0.37
	3	1.00	1.00	1.00	0.79	0.73	0.77	0.61	0.64	0.61	0.53	0.61	0.52	0.54	0.46	0.44	0.55	0.43	0.45	0.44	0.38	0.39	0.40
	3-1/2	1.00	1.00	1.00	0.92	0.85	0.90	0.72	0.75	0.71	0.62	0.72	0.61	0.63	0.53	0.51	0.64	0.50	0.52	0.52	0.44	0.45	0.47
	4	1.00	1.00	1.00	1.00	0.97	1.00	0.82	0.86	0.81	0.71	0.82	0.69	0.72	0.61	0.58	0.74	0.57	0.59	0.59	0.50	0.51	0.53
	4-1/2	1.00	1.00	1.00	1.00	1.00	1.00	0.92	0.97	0.91	0.80	0.92	0.78	0.81	0.68	0.66	0.83	0.65	0.67	0.67	0.56	0.58	0.60
	5	1.00	1.00	1.00	1.00	1.00	1.00	1.00	1.00	1.00	0.89	1.00	0.87	0.90	0.76	0.73	0.92	0.72	0.74	0.74	0.63	0.64	0.66
	5-1/2	1.00	1.00	1.00	1.00	1.00	1.00	1.00	1.00	1.00	0.97	1.00	0.95	0.99	0.84	0.80	1.00	0.79	0.82	0.82	0.69	0.71	0.73
	6	1.00	1.00	1.00	1.00	1.00	1.00	1.00	1.00	1.00	1.00	1.00	1.00	1.00	0.91	0.88	1.00	0.86	0.89	0.89	0.75	0.77	0.80
	6-1/2	1.00	1.00	1.00	1.00	1.00	1.00	1.00	1.00	1.00	1.00	1.00	1.00	1.00	0.99	0.95	1.00	0.93	0.97	0.96	0.81	0.84	0.86
	7	1.00	1.00	1.00	1.00	1.00	1.00	1.00	1.00	1.00	1.00	1.00	1.00	1.00	1.00	1.00	1.00	1.00	1.00	1.00	0.88	0.90	0.93
7-1/2	1.00	1.00	1.00	1.00	1.00	1.00	1.00	1.00	1.00	1.00	1.00	1.00	1.00	1.00	1.00	1.00	1.00	1.00	1.00	0.94	0.96	1.00	
8	1.00	1.00	1.00	1.00	1.00	1.00	1.00	1.00	1.00	1.00	1.00	1.00	1.00	1.00	1.00	1.00	1.00	1.00	1.00	1.00	1.00	1.00	

**Spacing Reduction Factors - Shear (F<sub>VS</sub>)**

Diameter (in)	1/4			3/8					1/2					5/8					3/4				
	Nominal Embedment h <sub>nom</sub> (in)	1	1-5/8	2-1/2	1-1/2	2	2-1/2	3-1/4	4-1/2	1-3/4	2-1/2	3	4-1/4	5-1/2	2-1/2	3-1/4	4	5	6-1/4	2-1/2	4-1/4	5	6-1/4
Minimum Spacing S <sub>min</sub> (in)	1-1/2	1-1/2	1-1/2	2	2	2	2	2	2-3/4	2-3/4	2-3/4	2-3/4	2-3/4	2-3/4	2-3/4	2-3/4	2-3/4	2-3/4	3	3	3	3	
Spacing Distance (inches)	1-1/2	0.60	0.60	0.60	-	-	-	-	-	-	-	-	-	-	-	-	-	-	-	-	-	-	
	1-3/4	0.61	0.62	0.61	-	-	-	-	-	-	-	-	-	-	-	-	-	-	-	-	-	-	
	2	0.63	0.64	0.63	0.59	0.58	0.59	0.57	0.57	-	-	-	-	-	-	-	-	-	-	-	-	-	
	2-1/4	0.65	0.66	0.65	0.60	0.59	0.60	0.58	0.58	-	-	-	-	-	-	-	-	-	-	-	-	-	
	2-1/2	0.66	0.67	0.66	0.61	0.60	0.61	0.59	0.59	-	-	-	-	-	-	-	-	-	-	-	-	-	
	2-3/4	0.68	0.69	0.68	0.62	0.61	0.62	0.59	0.60	0.59	0.58	0.59	0.58	0.58	0.57	0.57	0.58	0.57	0.57	-	-	-	-
	3	0.69	0.71	0.70	0.63	0.62	0.63	0.60	0.61	0.60	0.59	0.60	0.59	0.59	0.58	0.57	0.59	0.57	0.57	0.57	0.56	0.56	0.57
	3-1/2	0.73	0.74	0.73	0.65	0.64	0.65	0.62	0.63	0.62	0.60	0.62	0.60	0.60	0.59	0.59	0.61	0.58	0.59	0.59	0.57	0.57	0.58
	4	0.76	0.78	0.76	0.68	0.66	0.67	0.64	0.64	0.64	0.62	0.64	0.62	0.62	0.60	0.60	0.62	0.60	0.60	0.60	0.58	0.59	0.59
	4-1/2	0.79	0.81	0.79	0.70	0.68	0.69	0.65	0.66	0.65	0.63	0.65	0.63	0.63	0.61	0.61	0.64	0.61	0.61	0.61	0.59	0.60	0.60
	5	0.82	0.85	0.83	0.72	0.70	0.71	0.67	0.68	0.67	0.65	0.67	0.64	0.65	0.63	0.62	0.65	0.62	0.62	0.62	0.60	0.61	0.61
	5-1/2	0.86	0.88	0.86	0.74	0.72	0.74	0.69	0.70	0.69	0.66	0.69	0.66	0.66	0.64	0.63	0.67	0.63	0.64	0.64	0.61	0.62	0.62
	6	0.89	0.92	0.89	0.76	0.74	0.76	0.70	0.71	0.70	0.68	0.70	0.67	0.68	0.65	0.65	0.68	0.64	0.65	0.65	0.63	0.63	0.63
	6-1/2	0.92	0.95	0.92	0.79	0.76	0.78	0.72	0.73	0.72	0.69	0.72	0.69	0.69	0.66	0.66	0.70	0.66	0.66	0.66	0.64	0.64	0.64
	7	0.95	0.99	0.96	0.81	0.78	0.80	0.74	0.75	0.74	0.71	0.74	0.70	0.71	0.68	0.67	0.71	0.67	0.67	0.67	0.65	0.65	0.66
	7-1/2	0.99	1.00	0.99	0.83	0.80	0.82	0.76	0.77	0.75	0.72	0.76	0.72	0.72	0.69	0.68	0.73	0.68	0.69	0.69	0.66	0.66	0.67
	8	1.00	1.00	1.00	0.85	0.82	0.84	0.77	0.79	0.77	0.74	0.77	0.73	0.74	0.70	0.69	0.75	0.69	0.70	0.70	0.67	0.67	0.68
	9	1.00	1.00	1.00	0.90	0.87	0.89	0.81	0.82	0.80	0.77	0.81	0.76	0.77	0.73	0.72	0.78	0.72	0.72	0.72	0.69	0.69	0.70
	10	1.00	1.00	1.00	0.94	0.91	0.93	0.84	0.86	0.84	0.80	0.84	0.79	0.80	0.75	0.74	0.81	0.74	0.75	0.75	0.71	0.71	0.72
	11	1.00	1.00	1.00	0.98	0.95	0.97	0.87	0.89	0.87	0.82	0.87	0.82	0.83	0.78	0.77	0.84	0.76	0.77	0.77	0.73	0.74	0.74
	12	1.00	1.00	1.00	1.00	0.99	1.00	0.91	0.93	0.91	0.85	0.91	0.85	0.86	0.80	0.79	0.87	0.79	0.80	0.80	0.75	0.76	0.77
	13	1.00	1.00	1.00	1.00	1.00	1.00	0.94	0.96	0.94	0.88	0.94	0.88	0.89	0.83	0.82	0.90	0.81	0.82	0.82	0.77	0.78	0.79
	14	1.00	1.00	1.00	1.00	1.00	1.00	0.98	1.00	0.97	0.91	0.98	0.90	0.92	0.85	0.84	0.93	0.84	0.85	0.85	0.79	0.80	0.81
	15	1.00	1.00	1.00	1.00	1.00	1.00	1.00	1.00	1.00	0.94	1.00	0.93	0.95	0.88	0.86	0.96	0.86	0.87	0.87	0.81	0.82	0.83
16	1.00	1.00	1.00	1.00	1.00	1.00	1.00	1.00	1.00	0.97	1.00	0.96	0.98	0.91	0.89	0.99	0.88	0.90	0.90	0.83	0.84	0.85	
17	1.00	1.00	1.00	1.00	1.00	1.00	1.00	1.00	1.00	1.00	1.00	0.99	1.00	0.93	0.91	1.00	0.91	0.92	0.92	0.86	0.86	0.88	
18	1.00	1.00	1.00	1.00	1.00	1.00	1.00	1.00	1.00	1.00	1.00	1.00	1.00	0.96	0.94	1.00	0.93	0.95	0.94	0.88	0.89	0.90	
19	1.00	1.00	1.00	1.00	1.00	1.00	1.00	1.00	1.00	1.00	1.00	1.00	1.00	0.98	0.96	1.00	0.95	0.97	0.97	0.90	0.91	0.92	
20	1.00	1.00	1.00	1.00	1.00	1.00	1.00	1.00	1.00	1.00	1.00	1.00	1.00	1.00	0.99	1.00	0.98	1.00	0.99	0.92	0.93	0.94	
21	1.00	1.00	1.00	1.00	1.00	1.00	1.00	1.00	1.00	1.00	1.00	1.00	1.00	1.00	1.00	1.00	1.00	1.00	1.00	0.94	0.95	0.97	
22	1.00	1.00	1.00	1.00	1.00	1.00	1.00	1.00	1.00	1.00	1.00	1.00	1.00	1.00	1.00	1.00	1.00	1.00	1.00	0.96	0.97	0.99	
23	1.00	1.00	1.00	1.00	1.00	1.00	1.00	1.00	1.00	1.00	1.00	1.00	1.00	1.00	1.00	1.00	1.00	1.00	1.00	0.98	0.99	1.00	
24	1.00	1.00	1.00	1.00	1.00	1.00	1.00	1.00	1.00	1.00	1.00	1.00	1.00	1.00	1.00	1.00	1.00	1.00	1.00	1.00	1.00	1.00	

**Allowable Screw-Bolt+ Tension and Shear Load Capacities Installed into the face of Grout-Filled Concrete Masonry Units**<sup>1,2,3,4,5,6,7,8,9</sup>

**CODE LISTED**  
ICC-ES ESR-4042



Tension Load								
Anchor Diameter, d in.	Minimum Embedment h <sub>nom</sub> in. (mm)	Allowable Load at C <sub>cr</sub> and S <sub>cr</sub> lbs (kN)	Spacing Distance, s			Edge or End Distance, c <sub>2</sub> or c <sub>1</sub> (see Illustration of Screw-Bolt+ Installed into Grouted Concrete Masonry Wall detail)		
			Critical Distance, S <sub>cr</sub> in. (mm)	Minimum Distance, S <sub>min</sub> in. (mm)	Allowable Load Factor at S <sub>min</sub>	Critical Distance, c <sub>cr</sub> in. (mm)	Minimum Distance, C <sub>min</sub> in. (mm)	Allowable Load Factor at C <sub>min</sub>
1/4	1-5/8 (41)	315 (1.4)	4 (102)	2 (51)	1.00 (no reduction)	3-3/4 (95)	1-1/4 (32)	0.60
	2-1/2 (64)	605 (2.7)						
3/8	2 (51)	450 (2.0)	6 (152)	3 (76)	1.00 (no reduction)	6 (152)	1-1/2 (38)	0.70
	3-1/4 (83)	1,085 (4.8)						
1/2	2-1/2 (64)	610 (2.7)	8 (203)	4 (102)	1.00 (no reduction)	8 (203)	2-5/8 (67)	0.75
	4-1/4 (108)	1,190 (5.3)						
5/8	3-1/4 (83)	880 (3.9)	10 (254)	4 (102)	1.00 (no reduction)	10 (254)	3-3/8 (88)	0.90
	5 (127)	1,270 (5.6)						
3/4	4 (102)	1,150 (5.1)	12 (305)	4 (102)	1.00 (no reduction)	12 (305)	4 (102)	1.00 (no reduction)
	6-1/4 (159)	1,355 (6.0)						

Shear Load										
Anchor Diameter, d in.	Minimum Embedment h <sub>nom</sub> in. (mm)	Allowable Load at C <sub>cr</sub> and S <sub>cr</sub> Direction 1 & 2 lbs <sup>2</sup> (kN)	Allowable Load at C <sub>cr</sub> and S <sub>cr</sub> Direction 3 & 4 lbs <sup>2</sup> (kN)	Spacing Distance, s			Edge or End Distance, c <sub>2</sub> or c <sub>1</sub> (see Illustration of Screw-Bolt+ Installed into Grouted Concrete Masonry Wall)			
				Critical Distance, S <sub>cr</sub> in. (mm)	Minimum Distance, S <sub>min</sub> in. (mm)	Allowable Load Factor at S <sub>min</sub>	Critical Distance, C <sub>cr</sub> in. (mm)	Minimum Distance, C <sub>min</sub> in. (mm)	Allowable Load Factor at C <sub>min</sub>	
									Load Perpendicular to Edge or End (Direction 1 & 2) <sup>1</sup>	Load Perpendicular to Edge or End (Direction 3 & 4) <sup>1</sup>
1/4	1-5/8 (41)	400 (1.8)	400 (1.8)	4 (102)	2 (51)	1.00 (no reduction)	3-3/4 (95)	1-1/4 (32)	0.35	1.00 (no reduction)
	2-1/2 (64)	505 (2.2)	505 (2.2)							
3/8	2 (51)	815 (3.6)	815 (3.6)	6 (152)	3 (76)	1.00 (no reduction)	6 (152)	1-1/2 (38)	0.27	1.00 (no reduction)
	3-1/4 (83)	935 (4.2)	935 (4.2)							
1/2	2-1/2 (64)	1,380 (6.1)	1,380 (6.1)	8 (203)	4 (102)	1.00 (no reduction)	8 (203)	2-5/8 (67)	0.20	1.00 (no reduction)
	4-1/4 (108)	2,180 (9.7)	2,180 (9.7)							
5/8	3-1/4 (83)	2,090 (9.3)	2,225 (9.9)	10 (254)	4 (102)	1.00 (no reduction)	10 (254)	3-3/8 (86)	0.23	1.00 (no reduction)
	5 (127)	2,640 (11.7)	2,640 (11.7)							
3/4	4 (102)	2,800 (12.5)	3,330 (14.8)	12 (305)	4 (102)	1.00 (no reduction)	12 (305)	4 (102)	0.25	1.00 (no reduction)
	6-1/4 (159)	3,100 (13.8)	3,685 (16.4)							

For St: 1 inch = 25.4 mm; 1 lbs = 0.0044 kN, 1 psi = 0.006894 MPa.

1. All values are for anchors installed in fully grouted concrete masonry wall construction with materials meeting minimum compressive strength, f'm, of 1,500 psi (10.3 MPa). Concrete masonry units must be light-, medium-, or normal-weight conforming to ASTM C90. Allowable loads are based on a safety factor of 5.0.
2. Anchors may be installed in any location in the face of the masonry wall (cell, web, bed joint) except within 1-1/4-inch from the of the vertical mortar joint (head joint), center-to-center, provided the minimum edge and end distances are maintained. Anchors may not be placed in the head joint unless the vertical joint is mortared full-depth.
3. A maximum of two anchors may be installed in a single masonry cell in accordance with the spacing and edge or end distance requirements. Embedment is measured from the outside surface of the concrete masonry unit to the embedded end of the anchor. See the figure for Illustration of Screw-Bolt+ Anchors Installed into Grouted Concrete Masonry Wall.
4. The critical spacing distance, S<sub>cr</sub>, is the anchor spacing where full load values in the table may be used. The minimum spacing distance, S<sub>min</sub>, is the minimum anchor spacing for which values are available and installation is permitted. Spacing distance is measured from the centerline to centerline between two anchors.
5. The critical edge or end distance, C<sub>cr</sub>, is the distance where full load values in the table may be used. The minimum edge or end distance, C<sub>min</sub>, is the minimum distance for which values are available and installation is permitted. Edge or end distance is measured from anchor centerline to the closest unrestrained edge.
6. The tabulated values are applicable for anchors installed into the ends of grout-filled concrete masonry units (e.g. wall opening) where minimum edge distances are maintained.
7. Load values for anchors installed less than S<sub>cr</sub> and C<sub>cr</sub> must be multiplied by the appropriate load reduction factor based on actual spacing (s) or edge distance (c). Load factors are multiplicative; both spacing and edge reduction factors must be considered.
8. Linear interpolation of load values between minimum spacing (S<sub>min</sub>) and critical spacing (S<sub>cr</sub>) and between minimum edge or end distance (C<sub>min</sub>) and critical edge or end distance (C<sub>cr</sub>) is permitted.
9. See the figure for Direction of Shear Loading in Relation to Edge and End of Masonry Wall figure for illustration of shear load directions.

**MECHANICAL ANCHORS**

**SCREW-BOLT+™**  
High Performance Screw Anchor

**Illustration of Screw-Bolt+ Anchors Installed into Grouted Concrete Masonry Wall**

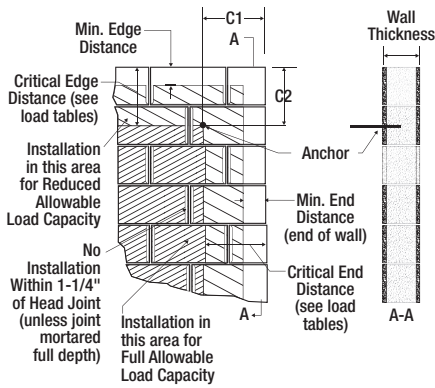

**Direction of Shear Loading in Relation to Edge and End of Masonry Wall**

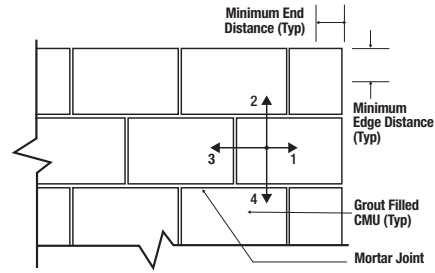

1. Shear load perpendicular to End and parallel to Edge
2. Shear load perpendicular to Edge and parallel to End
3. Shear load parallel to Edge and perpendicular away from End
4. Shear load parallel to End and perpendicular to bottom of wall

**Allowable Screw-Bolt+ Tension and Shear Load Capacities Installed into the Tops of Grout-Filled Concrete Masonry Units** <sup>1,2,3,4,5,6,7,8,9,10</sup>

**CODE LISTED**  
ICC-ES ESR-4042



Anchor Diameter d in.	Minimum Embedment h <sub>nom</sub> in. (mm)	Minimum Spacing Distance in. (mm)	Minimum Edge Distance in. (mm)	Minimum End Distance in. (mm)	Tension Load lbs (kN)	Shear Load, lb (kN)	
						Load Perpendicular to Edge of Masonry Wall (   to end)	Load Parallel to Edge of Masonry Wall (⊥ to end)
1/4	2-1/2 (64)	1-1/2 (38)	1-1/2 (38)	4 (102)	410 (1.8)	185 (0.8)	185 (0.8)
		1-1/2 (38)	3-1/2 (89)	4 (102)	485 (2.2)	215 (1.0)	215 (1.0)
3/8	3-1/4 (83)	2 (51)	1-1/2 (38)	4 (102)	625 (2.8)	225 (1.0)	505 (2.2)
		2 (51)	3-1/2 (89)	6 (153)	625 (2.8)	560 (2.5)	560 (2.5)
1/2	4-1/4 (108)	8 (203) [see Note 4 for reduced minimum spacing distances]	1-3/4 (45)	8 (203)	810 (3.6)	255 (1.1)	580 (2.6)
			3-3/4 (95)		1,210 (5.4)	645 (2.9)	1,030 (4.6)
5/8	5 (127)	10 (254)	1-3/4 (45)	10 (254)	900 (4.0)	260 (1.2)	950 (4.2)
3/4	6-1/4 (159)	12 (301)	1-3/4 (45)	12 (305)	1,215 (5.4)	260 (1.2)	990 (4.4)

For SI: 1 inch = 25.4 mm; 1 lbs = 0.0044 kN, 1 psi = 0.006894 MPa.

1. All values are for anchors installed in fully grouted concrete masonry wall construction with materials meeting minimum compressive strength, f'm, of 1,500 psi (10.3 MPa). Concrete masonry units must be light-, medium-, or normal-weight conforming to ASTM C90. Allowable loads are based on a safety factor of 5.0.
2. Anchors may be installed in any location in the top of the masonry wall except within 1-1/4-inch from the mortar joint (head joint), provided the minimum edge and end distances are maintained.
3. A maximum of two anchors may be installed in a single masonry cell in accordance with the spacing and edge or end distance requirements. Embedment is measured from the outside surface of the concrete masonry unit to the embedded end of the anchor. See figure for Screw-Bolt+ Anchors Installed into the Top of Grouted Concrete Masonry Wall.
4. Minimum spacing distance for 1/2-inch-diameter anchors shall be 8 inches and may be reduced to 2 inches provided the allowable load reduction factor of 0.40 is applied. Linear interpolation may be used to determine the reduction factor for intermediate anchor spacing distances between 8 inches and 2 inches.
5. Spacing distance is measured from the centerline to centerline between two anchors.
6. Linear interpolation may be used for 1/4-inch and 3/8-inch-diameter anchors to determine allowable loads for edge distances between 3-1/2-inches and 1-1/2-inches.
7. Linear interpolation may be used for 1/2-inch-diameter anchors to determine allowable loads for edge distances between 3-3/4-inches and 1-3/4-inches.
8. The edge and end distance is measured from the anchor centerline to the closest unrestrained edge and end of the CMU block, respectively. See figure for Screw-Bolt+ Anchors Installed into the Top of Grouted Concrete Masonry Wall.
9. Spacing distance is measured from the centerline to centerline between two anchors.
10. Allowable shear loads parallel and perpendicular to the edge of a masonry wall may be applied in or out of plane, respectively. See figure for Screw-Bolt+ Anchors Installed into the Top of Grouted Concrete Masonry Wall.

**Screw-Bolt+ Anchors Installed into the Top of Grouted Concrete Masonry Wall**

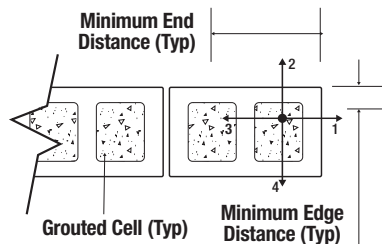

1. Shear load perpendicular to End and parallel to Edge
2. Shear load perpendicular to Edge and parallel to End
3. Shear load parallel to Edge and perpendicular away from End
4. Shear load parallel to End and perpendicular to bottom of wall





**Allowable Screw-Bolt+ Tension and Shear Load Capacities Installed into the Face of Brick Masonry Walls**<sup>1,2,3,4,5,6,7,8</sup>

Tension Load								
Anchor Diameter, d in.	Minimum Embedment, h <sub>nom</sub> in. (mm)	Allowable Load at C <sub>cr</sub> and S <sub>cr</sub> lbs (kN)	Spacing Distance, s			Edge or End Distance		
			Critical Distance, S <sub>cr</sub> in. (mm)	Minimum Distance, S <sub>min</sub> in. (mm)	Allowable Load Factor at S <sub>min</sub> in. (mm)	Critical Distance, C <sub>cr</sub> in. (mm)	Minimum Distance, C <sub>min</sub> in. (mm)	Allowable Load Factor at C <sub>min</sub>
1/4	1-5/8 (41)	550 (2.4)	4 (102)	2 (51)	0.60	3-3/4 (95)	1-1/4 (32)	0.25
	2-1/2 (64)	830 (3.7)						
3/8	2 (51)	905 (4.0)	6 (152)	3 (76)	0.60	6 (152)	1-1/2 (38)	0.50
	3-1/4 (82)	1,115 (5.0)						
1/2	2-1/2 (64)	1,015 (4.5)	8 (203)	4 (102)	0.60	8 (203)	2-5/8 (68)	0.50
	4-1/4 (108)	1,495 (6.7)						
5/8	3-1/4 (83)	1,025 (4.6)	10 (254)	5 (127)	0.50	10 (254)	3-3/8 (86)	0.50
	5 (127)	2,015 (9.0)						
3/4	4 (102)	1,815 (8.1)	12 (305)	6 (152)	0.50	12 (305)	4 (102)	0.50
	6-1/4 (159)	2,400 (10.7)						

Shear Load								
Anchor Diameter, d in.	Minimum Embedment, h <sub>nom</sub> in. (mm)	Allowable Load at C <sub>cr</sub> and S <sub>cr</sub> lbs (kN)	Spacing Distance, s			Edge or End Distance		
			Critical Distance, S <sub>cr</sub> in. (mm)	Minimum Distance, S <sub>min</sub> in. (mm)	Allowable Load Factor at S <sub>min</sub> in. (mm)	Critical Distance, C <sub>cr</sub> in. (mm)	Minimum Distance, C <sub>min</sub> in. (mm)	Allowable Load Factor at C <sub>min</sub> Load Perpendicular to Edge or End
1/4	1-5/8 (41)	405 (1.8)	4 (102)	2 (51)	0.70	3-3/4 (95)	1-1/4 (32)	0.20
	2-1/2 (62)	520 (2.3)						
3/8	2 (51)	930 (4.1)	6 (152)	3 (76)	0.70	6 (152)	1-1/2 (39)	0.20
	3-1/4 (83)	1,030 (4.6)						
1/2	2-1/2 (64)	1,055 (4.7)	8 (203)	4 (102)	0.65	8 (203)	2-5/8 (67)	0.25
	4-1/4 (108)	1,075 (4.8)						
5/8	3-1/4 (83)	1,700 (7.6)	10 (254)	5 (127)	0.50	10 (254)	3-3/8 (86)	0.40
	5 (127)	1,980 (8.8)						
3/4	4 (102)	1,700 (7.6)	12 (305)	6 (152)	0.50	12 (305)	4 (102)	0.55
	6-1/4 (159)	2,030 (9.0)						

For Sl: 1 inch = 25.4 mm; 1 lbs = 0.0044 kN, 1 psi = 0.006894 MPa.

- All values are for anchors installed in minimum two-wythe, solid clay brick masonry walls conforming to ASTM C62, grade SW minimum. Mortar must be type N, S or M. The base material must have a minimum compressive strength, f<sub>m</sub>, of 2,000 psi (13.8 MPa). Allowable loads are based on a safety factor of 5.0.
- Anchors may be installed in any location in the face of the masonry wall, provided the minimum edge and end distances are maintained.
- Embedment is measured from the outside surface of the concrete masonry unit to the embedded end of the anchor.
- The critical spacing distance, S<sub>cr</sub>, is the anchor spacing where full load values in the table may be used. The minimum spacing distance, S<sub>min</sub>, is the minimum anchor spacing for which values are available and installation is permitted. Spacing distance is measured from the centerline to centerline between two anchors.
- The critical edge or end distance, C<sub>cr</sub>, is the distance where full load values in the table may be used. The minimum edge or end distance, C<sub>min</sub>, is the minimum distance for which values are available and installation is permitted. Edge or end distance is measured from anchor centerline to the closest unrestrained edge.
- The tabulated values are applicable for anchors installed into wall openings where minimum edge distances are maintained.
- Load values for anchors installed less than S<sub>cr</sub> and C<sub>cr</sub> must be multiplied by the appropriate load reduction factor based on actual spacing (s) or edge distance (c). Load factors are multiplicative; both spacing and edge reduction factors must be considered.
- Linear interpolation of load values between minimum spacing (S<sub>min</sub>) and critical spacing (S<sub>cr</sub>) and between minimum edge or end distance (C<sub>min</sub>) and critical edge or end distance (C<sub>cr</sub>) is permitted.

**MECHANICAL ANCHORS**

**SCREW-BOLT+**<sup>TM</sup>  
High Performance Screw Anchor

**STRENGTH DESIGN INFORMATION**

**Screw-Bolt+ Installation Specifications in Concrete and Supplemental Information<sup>1,2,3,4</sup>**

Anchor Property/ Setting Information	Notation	Units	Nominal Anchor Diameter (inch)											
			1/4		3/8			1/2			5/8		3/4	
Head Style	-	-	Hex or Flat Head		Hex or Flat Head			Hex or Flat Head			Hex Head		Hex Head	
Nominal anchor diameter	$d_a$	in. (mm)	0.250 (6.4)		0.375 (9.5)			0.500 (12.7)			0.625 (15.9)		0.750 (19.1)	
Minimum diameter of hole clearance in fixture <sup>8</sup>	$d_h$	in. (mm)	11/32 (8.7)		1/2 (12.7)			5/8 (15.9)			3/4 (19.1)		7/8 (22.2)	
Drill bit diameter (ANSI)	$d_{bit}$	in.	1/4		3/8			1/2			5/8		3/4	
Minimum nominal embedment depth <sup>5</sup>	$h_{nom}$	in. (mm)	1-5/8 (41)	2-1/2 (64)	2 (51)	2-1/2 (64)	3-1/4 (83)	2-1/2 (64)	3 (76)	4-1/4 (108)	3-1/4 (64)	4 (64)	5 (127)	4-1/4 (108)
Effective Embedment	$h_{ef}$	in. (mm)	1.20 (30)	1.94 (49)	1.33 (34)	1.75 (44)	2.39 (61)	1.75 (44)	2.17 (55)	3.23 (82)	2.24 (57)	2.88 (73)	3.73 (95)	3.08 (78)
Minimum hole depth	$h_{hole}$	in. (mm)	2 (51)	2-7/8 (73)	2-3/8 (60)	2-7/8 (73)	3-5/8 (92)	2-7/8 (73)	3-3/8 (86)	4-5/8 (117)	3-5/8 (92)	4-3/8 (111)	5-3/8 (137)	4-5/8 (117)
Minimum concrete member thickness	$h_{min}$	in. (mm)	3-1/4 (83)	4 (102)	3-1/2 (89)	4 (102)	5 (127)	4 (102)	5 (127)	6-1/2 (165)	5 (127)	6 (152)	7 (178)	6 (152)
Minimum edge distance <sup>6</sup>	$c_{min}$	in. (mm)	1-1/2 (38)		$c_{min} = 1-1/2$ (38) for $s_{min} \geq 3$ (76) $s_{min} = 2$ (51) for $c_{min} \geq 2$ (51)			1-3/4 (44)			1-3/4 (44)		1-3/4 (44)	
Minimum spacing distance <sup>6</sup>	$s_{min}$	in. (mm)	1-1/2 (38)					2-3/4 (70)			2-3/4 (70)		2-3/4 (70)	
Minimum overall anchor length <sup>7,9</sup>	$\ell_{anch}$	in.	1-3/4	2-5/8	2-1/2	3	4	3	4	5	4	5	6	5
Maximum manual installation torque	$T_{inst,max}$	ft.-lbf. (N-m)	19 (26)	25 (34)	25 (34)	25 (34)	40 (54)	45 (61)	45 (61)	60 (81)	60 (81)		70 (95)	
Maximum impact wrench power (torque)	$T_{impact,max}$	ft.-lbf. (N-m)	150 (203)		300 (407)			300 (407)			700 (950)		700 (950)	
Hex Head	Wrench socket size	-	in. 7/16		9/16			3/4			15/16		1-1/8	
	Maximum head height	-	in. 21/64		3/8			31/64			37/64		43/64	
	Max washer diameter	-	in. 37/64		3/4			1-1/16			1-1/8		1-13/32	
Flat Head	Driver size	-	in. T-30		T-50			T-55			-		-	
	Max head height	-	in. 13/64		21/64			11/32			-		-	
	Max head diameter	-	in. 17/32		57/64			1			-		-	
	Countersunk angle	-	in. 82		82			82			-		-	
Effective tensile stress area (screw anchor body)	$A_{se}$	in <sup>2</sup> (mm <sup>2</sup> )	0.045 (29.0)		0.094 (60.6)			0.176 (113.5)			0.274 (176.8)		0.399 (257.4)	
Minimum specified ultimate strength	$f_{uta}$	ksi (N/mm <sup>2</sup> )	100 (690)		105 (724)			115 (794)			95 (656)		95 (656)	
Minimum specified yield strength	$f_y$	ksi (N/mm <sup>2</sup> )	80 (552)		84 (579)			92 (635)			76 (524)		76 (524)	
Mean axial stiffness <sup>9,10</sup>	Uncracked concrete	$\beta_{uncr}$	lbf/in 1,252,000		1,157,000			1,014,000			919,000		1,028,000	
	Cracked concrete	$\beta_{cr}$	lbf/in 355,000		330,000			349,000			378,000		419,000	

For SI: 1 inch = 25.4 mm; 1 ksi = 6.894 N/mm<sup>2</sup>; 1 ft-lb = 1.356 N-m; 1 lb = 0.0044 kN.

- The information presented in this table is to be used in conjunction with the design criteria of ACI 318(-19 or -14) Chapter 17 or ACI 318-11 Appendix D, as applicable.
- For installations in the topside of concrete-filled steel deck assemblies with minimum concrete member thickness,  $h_{min,deck}$ , of 2.5 inches above the upper flute (topping thickness). See the table for anchor setting information for installation on the top of concrete-filled steel deck assemblies and the top of concrete over steel deck installation detail.
- For installations in the topside of concrete-filled steel deck assemblies with sand-lightweight concrete fill, the maximum installation torque,  $T_{inst,max}$ , is 18 ft.-lb.
- For installations through the soffit of steel deck assemblies into concrete, see the design information table for installation in the soffit of concrete-filled steel deck assemblies and the installation details in the soffit of concrete over steel deck for the applicable steel deck profile. Tabulated minimum spacing values are based on anchors installed along the flute with axial spacing equal to the greater of  $3h_{ef}$  or 1.5 times the flute width.
- The embedment depth,  $h_{nom}$ , is measured from the outside surface of the concrete member to the embedded end of the anchor.
- Additional combinations for minimum edge distance,  $c_{min}$ , and minimum spacing distance,  $s_{min}$ , may be derived by linear interpolation between the given boundary values for the 3/8-inch diameter anchors.
- The listed minimum overall anchor length is based on the anchor sizes commercially available at the time of publication compared with the requirements to achieve the minimum nominal embedment depth. The minimum nominal length for hex head anchors is measured from under the head to the tip of the anchor, the minimum nominal length for flat head anchors is measured from the top of the head to the tip of the anchor.
- The minimum diameter of fixture hole clearance is for the body of the anchor to pass through structural steel members; clearance holes may be 1/8-inch less than tabulated values (same as nominal drill bit diameter) provided the screw anchors are installed through light gauge cold-formed steel members or wood members.
- Hex head anchors with the following minimum lengths are also suitable for use with cold-formed steel members provided the nominal thickness of the fixture attachments does not exceed 20 gauges (0.036-inch base metal thickness):  
 For 3/8-inch-diameter anchors with 2-1/2-inch nominal embedment, 2-1/2-inch long anchors.  
 For 1/2-inch-diameter anchors with 2-1/2-inch nominal embedment, 2-1/2-inch long anchors.  
 For 1/2-inch-diameter anchors with 3-inch nominal embedment, 3-inch long anchors.  
 For 5/8-inch-diameter anchors with 4-inch nominal embedment, 4-inch long anchors.  
 For 5/8-inch-diameter anchors with 5-inch nominal embedment, 5-inch long anchors.
- Mean values shown, actual stiffness varies considerably depending on concrete strength, loading and geometry of application.

**Anchor Setting Information for Installation on the Top of Concrete-Filled Steel Deck Assemblies with Minimum Topping Thickness<sup>1,2,3,4</sup>**

Anchor Property / Setting Information	Notation	Units	Nominal Anchor Size (inch)		
			1/4	3/8	1/2
Head style	-	-	Hex Head or Flat Head		Hex Head or Flat Head
Nominal anchor diameter	$d_a$	in. (mm)	0.250 (6.4)	0.375 (9.5)	0.500 (12.7)
Minimum diameter of hole clearance in fixture <sup>8</sup>	$d_h$	in. (mm)	11/32 (8.7)	1/2 (12.7)	5/8 (15.9)
Nominal drill bit diameter (ANSI)	$d_{bit}$	in.	1/4		3/8
Minimum nominal embedment depth <sup>5</sup>	$h_{nom}$	in. (mm)	1-5/8 (41)	2-1/2 (64)	2 (51)
Effective embedment	$h_{ef}$	in. (mm)	1.20 (30)	1.94 (49)	1.33 (33)
Minimum hole depth	$h_o$	in. (mm)	2 (51)	2-1/2 (64)	2-3/8 (60)
Minimum concrete member thickness (topping thickness)	$h_{min,deck}$	in. (mm)	2-1/2 (64)	2-1/2 (64)	2-1/2 (64)
Minimum edge distance	$C_{min,deck,top}$	in. (mm)	1-1/2 (38)		2 (51)
Minimum spacing distance	$S_{min,deck,top}$	in. (mm)	1-1/2 (38)		2 (51)
Minimum nominal anchor length <sup>6,9</sup>	$\ell_{anch}$	in.	1-3/4	2-5/8	2-1/2
Maximum impact wrench power (torque)	$T_{impact,max}$	ft.-lb. (N-m)	150 (203)		300 (407)
Max. manual installation torque	$T_{inst,max}$	ft.-lb. (N-m)	18 <sup>(7)</sup> (26)	25 (34)	25 (34)
Hex Head	Wrench socket size	in.	7/16		9/16
	Max. head height	in.	21/64		3/8
	Max. washer diameter	in.	37/64		3/4
Flat Head	Driver Size	in.	T-30		T-50
	Max head height	in.	13/64		21/64
	Max head diameter	in.	17/32		57/64
	Countersunk angle	in.	82		82

For St: 1 inch = 25.4 mm; 1 ksi = 6.894 N/mm<sup>2</sup>; 1 ft-lb = 1.356 N-m; 1 lb = 0.0044 kN.

- The anchors may be installed in the topside of concrete-filled steel deck floor and roof assemblies in accordance with this table, the anchor installation specifications in concrete table and the top of concrete over steel deck installation detail provided the concrete thickness above the upper flute meets the minimum thicknesses specified in this table. Minimum concrete member thickness,  $h_{min,deck}$ , refers to the concrete thickness above the upper flute (topping thickness). See the top of concrete over steel deck installation detail.
- Applicable to the following conditions:  
 For 1/4-inch-diameter anchors with 1-5/8-inch nominal embedment,  $2-1/2\text{-inch} \leq h_{min,deck} < 3-1/4\text{-inch}$ .  
 For 1/4-inch-diameter anchors with 2-1/2-inch nominal embedment,  $2-1/2\text{-inch} \leq h_{min,deck} < 4\text{-inch}$ .  
 For 3/8-inch-diameter anchors with 2-inch nominal embedment,  $2-1/2\text{-inch} \leq h_{min,deck} < 3-1/2\text{-inch}$ .  
 For 1/2-inch-diameter anchors with 2-1/2-inch nominal embedment,  $2-1/2\text{-inch} \leq h_{min,deck} < 4-1/2\text{-inch}$ .
- For all other anchor diameters and embedment depths, refer to the anchor installation specifications in concrete table for applicable values of  $h_{min}$ ,  $C_{min}$  and  $S_{min}$ , which can be substituted for  $h_{min,deck}$ ,  $C_{min,deck,top}$  and  $S_{min,deck,top}$ , respectively.
- Design capacities shall be based on calculations according to values in Tension Design Information and the Shear Design Information tables.
- The embedment depth,  $h_{nom}$ , is measured from the outside surface of the concrete member to the embedded end of the anchor.
- The listed minimum overall anchor length is based on the anchor sizes commercially available at the time of publication compared with the requirements to achieve the minimum nominal embedment depth, including consideration of a fixture attachment. The minimum nominal length for hex head anchors is measured from under the head to the tip of the anchor, the minimum nominal length for flat head anchors is measured from the top of the head to the tip of the anchor.
- For installations in the topside of concrete-filled steel deck assemblies with normal-weight concrete fill, a maximum installation torque,  $T_{inst,max}$ , of 19 ft.-lb is allowed.
- The minimum diameter of fixture hole clearance is for the body of the anchor to pass through structural steel members; clearance holes may be 1/8-inch less than tabulated values (same as nominal drill bit diameter) provided the screw anchors are installed through light gauge cold-formed steel members or wood members.
- Hex head anchors with the following minimum lengths are also suitable for use with cold-formed steel members provided the nominal thickness of the fixture attachments does not exceed 20 gauges (0.036-inch base metal thickness):  
 For 1/2-inch-diameters anchors with 2-1/2-inch nominal embedment, 2-1/2-inch long anchors.

### Installation Detail for Anchors in the Top of Concrete Over Steel Deck Floor and Roof Assemblies with Minimum Topping Thickness (See Dimensional Profile Requirements)<sup>1,2</sup>

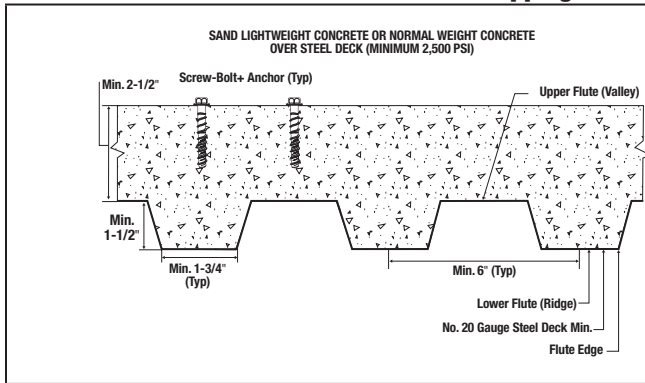

1. Anchors may be placed in the top side of concrete over steel deck profiles provided the minimum concrete thickness above the upper flange (topping thickness), minimum spacing distance and minimum edge distances are satisfied as given in Anchor Setting Information for Installation on the Top of Concrete-Filled Steel Deck Assemblies with Minimum Topping Thickness table.
2. For all other anchor diameters and embedment depths installed in the top of concrete over steel deck profiles with topping thickness greater than or equal to the minimum concrete member thicknesses given in the Installation Specifications in Concrete table, the minimum spacing distances and minimum edge distances must be used from the Installation Specifications in Concrete table, as applicable.

### Screw-Bolt+ Installation Detail for Anchors in the Soffit of Concrete Over Steel Deck Floor and Roof Assemblies (See Dimensional Profile Requirements)<sup>1,2,3</sup>

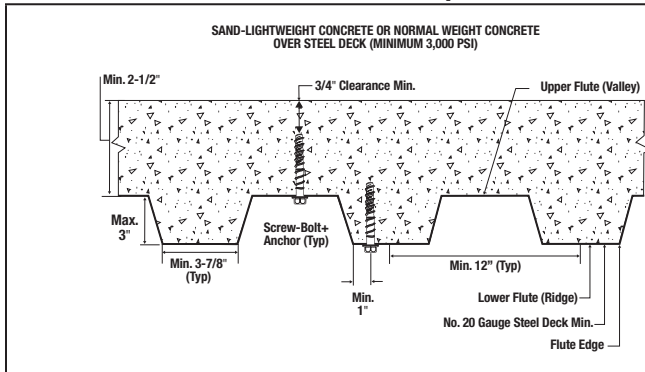

1. Anchors may be placed in the upper flange or lower flange of concrete-filled steel deck profiles provided the minimum hole clearance of 3/4-inch is satisfied for the selected anchor. See the Tension and Shear Design information for Anchors Installed in the Soffit of Concrete-Filled Steel Deck Assemblies table.
2. Anchors in the lower flange may be installed with a maximum 15/16 -inch offset in either direction from the center of the flange. The offset distance may be increased proportionally for profiles with lower flange widths greater than those shown provided the minimum lower flange edge distance is also satisfied (e.g. 1-1/4 -inch offset for 4-1/2-inch wide flange).
3. See the Tension and Shear Design information for Anchors Installed in the Soffit of Concrete-Filled Steel Deck Assemblies table for design data.

### Screw-Bolt+ Installation Detail for Anchors in the Soffit of Concrete Over Steel Deck Floor and Roof Assemblies (See Dimensional Profile Requirements)<sup>1,2,3</sup>

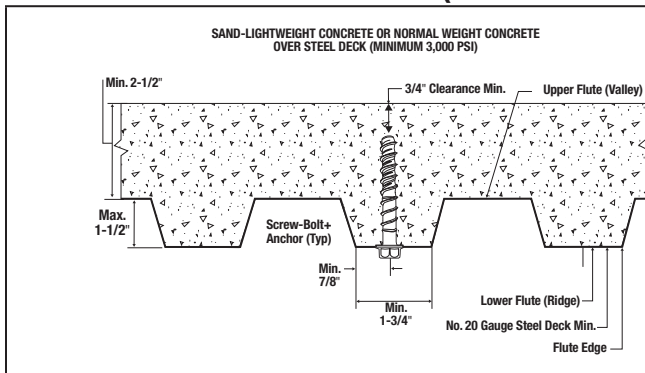

1. Anchors may be placed in the upper flange or lower flange of the concrete-filled steel deck profiles provided the minimum hole clearance of 3/4-inch is satisfied for the selected anchor. See the Tension and Shear Design information for Anchors Installed in the Soffit of Concrete-Filled Steel Deck Assemblies table.
2. Anchors in the lower flange may be installed in the center of the flange. An offset distance may be given proportionally for profiles with flange widths greater than those shown provided the minimum lower flange edge distance is also satisfied.
3. See the Tension and Shear Design information for Anchors Installed in the Soffit of Concrete-Filled Steel Deck Assemblies table for design data.

**Tension Design Information For Screw-Bolt+ Anchor In Concrete<sup>1,2</sup>**

**CODE LISTED**  
ICC-ES ESR-3889



Design Characteristic	Notation	Units	Nominal Anchor Diameter												
			1/4		3/8			1/2			5/8			3/4	
Anchor category	1, 2 or 3	-	1												
Minimum nominal embedment depth	$h_{nom}$	in. (mm)	1-5/8 (41)	2-1/2 (64)	2 (51)	2-1/2 (64)	3-1/4 (83)	2-1/2 (64)	3 (76)	4-1/4 (108)	3-1/4 (64)	4 (64)	5 (127)	4-1/4 (108)	
Effective embedment	$h_{ef}$	in. (mm)	1.20 (30)	1.94 (49)	1.33 (34)	1.75 (44)	2.39 (61)	1.75 (44)	2.17 (55)	3.23 (82)	2.24 (57)	2.88 (73)	3.73 (95)	3.08 (78)	
<b>Steel Strength in Tension (ACI 318-19 17.6.1, ACI 318-14 17.4.1 or ACI 318-11 D.5.1)</b>															
Steel strength in tension	$N_{sa}^{10}$	lb (kN)	4,535 (20.2)		8,730 (38.8)			20,475 (91.1)			26,260 (116.8)			38,165 (169.8)	
Reduction factor for steel strength <sup>3,4</sup>	$\phi$	-	0.65												
<b>Concrete Breakout Strength in Tension (ACI 318-19 17.6.2, ACI 318-14 17.4.2 or ACI 318-11 D.5.2)</b>															
Critical edge distance (uncracked concrete only)	$C_{ac}$	in. (mm)	4.30 (109)	6.10 (155)	5.00 (127)	6.30 (160)	7.80 (198)	3.30 (84)	5.90 (150)	8.10 (206)	6.30 (160)	7.90 (201)	10.10 (257)	10.90 (277)	
Critical edge distance, topside of concrete-filled steel decks with minimum topping thickness <sup>9</sup> (uncracked concrete only)	$C_{ac,deck,top}$	in. (mm)	3.00 (76)	4.00 (102)	3.50 (89)	- <sup>11</sup>	- <sup>11</sup>	6.00 (152)	- <sup>11</sup>	- <sup>11</sup>	- <sup>11</sup>	- <sup>11</sup>	- <sup>11</sup>	- <sup>11</sup>	
Effectiveness factor for uncracked concrete	$k_{unscr}$	-	27	24	30	24	24	30	24	24	30	24	24	27	
Effectiveness factor for cracked concrete	$k_{cr}$	-	17			17			17			21			17
Modification factor for cracked and uncracked concrete <sup>5</sup>	$\Psi_{c,N}$	-	1.0			1.0			1.0			1.0			1.0
Reduction factor for concrete breakout strength <sup>3</sup>	$\phi$	-	0.65 (Condition B)												
<b>Pullout Strength in Tension (ACI 318-19 17.6.3, ACI 318-14 17.4.3 or ACI 318-11 D.5.3)</b>															
Characteristic pullout strength, uncracked concrete (2,500 psi) <sup>6,10</sup>	$N_{p,unscr}$	lb (kN)	See Note 7			See Note 7			See Note 7			See Note 7			See Note 7
Characteristic pullout strength, cracked concrete (2,500 psi) <sup>6,10</sup>	$N_{p,cr}$	lb (kN)	765 (3.4)	1,415 (6.3)	See Note 7			1,645 (7.3)	2,515 (11.2)	4,700 (20.9)	3,080 (13.7)	4,720 (21.0)	6,900 (30.7)	See Note 7	
Reduction factor for pullout strength <sup>3</sup>	$\phi$	-	0.65 (Condition B)												
<b>Pullout Strength in Tension for Seismic Applications (ACI 318-19 17.10.3, ACI 318-14 17.2.3.3 or ACI 318-11 D.3.3.3)</b>															
Characteristic pullout strength, seismic (2,500 psi) <sup>6,8,10</sup>	$N_{eq}$	lb	360 (1.6)	1,170 (5.2)	900 (4.0)	1,645 (7.3)	2,765 (12.3)	1,645 (7.3)	2,515 (11.2)	4,700 (20.9)	1,910 (8.5)	2,445 (10.9)	3,370 (15.0)	4,085 (18.2)	
Reduction factor for pullout strength <sup>3</sup>	$\phi$	-	0.65 (Condition B)												

For Sl: 1 inch = 25.4 mm; 1 ksi = 6.894 N/mm<sup>2</sup>; 1 ft-lb = 1.356 N-m; 1 lb = 0.0044 kN.

- The data in this table is intended to be used with the design provisions of ACI 318 (-19 or -14) Chapter 17 or ACI 318-11 Appendix D, as applicable; for anchors resisting seismic load combinations the additional requirements of ACI 318-19 17.10, ACI 318-14 17.2.3 or ACI 318-11 D.3.3, as applicable, shall apply.
- Installation must comply with published instructions and details.
- All values of  $\phi$  were determined from the load combinations of IBC Section 1605.2, ACI 318 (-19 or -14) Section 5.3, or ACI 318-11 Section 9.2. If the load combinations of ACI 318-11 Appendix C are used, then the appropriate value of  $\phi$  must be determined in accordance with ACI 318-11 D.4.4. For reinforcement that complies with ACI 318 (-19 or -14) Chapter 17 or ACI 318-11 Appendix D requirements for Condition A, see ACI 318-14 17.3.3(c) or ACI 318-11 Section D.4.3(c), as applicable for the appropriate  $\phi$  factor when the load combinations of IBC Section 1605.2, ACI 318 (-19 or -14) Section 5.3 or ACI 318-11 Section 9.2 are used.
- The anchors are considered a brittle steel elements as defined by ACI 318 (-19 or -14) 2.3 or ACI 318-11 D.1, as applicable.
- Select the appropriate effectiveness factor for cracked concrete ( $k_{cr}$ ) or uncracked concrete ( $k_{unscr}$ ) and use  $\Psi_{c,N} = 1.0$ .
- For all design cases  $\Psi_{c,P} = 1.0$ . The characteristic pullout strength,  $N_{p,n}$ , for concrete compressive strengths greater than 2,500 psi for 1/4-inch-diameter anchors may be increased by multiplying the value in the table by  $(f'c / 2,500)^{0.3}$  for psi or  $(f'c / 17.2)^{0.3}$  for MPa. The characteristic pullout strength,  $N_{p,n}$ , for concrete compressive strengths greater than 2,500 psi for 3/8-inch- to 3/4-inch-diameter anchors may be increased by multiplying the value in the table by  $(f'c / 2,500)^{0.3}$  for psi or  $(f'c / 17.2)^{0.3}$  for MPa.
- Pullout strength does not control design of indicated anchors and does not need to be calculated for indicated anchor size and embedment.
- Reported values for characteristic pullout strength in tension for seismic applications are based on test results per ACI 355.2, Section 9.5.Y
- Anchors are permitted in the topside of concrete-filled steel deck assemblies in accordance with the Installation Detail for Anchors in the Top of Concrete Over Steel Deck Floor and Roof Assemblies with Minimum Topping Thickness.
- Anchors are permitted to be used in lightweight concrete provided the modification factor  $\lambda_a$  equal to  $0.8\lambda$  is applied to all values of  $f'c$  affecting  $N_n$ .
- Tabulated critical edge distance values,  $C_{ac,deck,top}$ , are for anchors installed in the top of concrete over steel deck profiles with a minimum concrete thickness,  $t_{min,deck}$ , of 2.5 inches above the upper flute (topping thickness). For minimum topping thickness greater than or equal to the minimum concrete member thicknesses,  $t_{min}$ , given in the Installation Specifications table, the associated critical edge distance,  $C_{ac}$ , for indicated anchor diameters and embedment depths may be used in the calculation of  $\Psi_{cp,N}$  as applicable.

**MECHANICAL ANCHORS**  
**SCREW-BOLT+™**  
High Performance Screw Anchor

TECHNICAL GUIDE – MECHANICAL ANCHORS ©2023 DEWALT – REV G

**Shear Design Information for Screw-Bolt+ Anchor in Concrete<sup>1,2,7,8</sup>**

**CODE LISTED**  
ICC-ES ESR-3889



Design Characteristic	Notation	Units	Nominal Anchor Diameter											
			1/4		3/8			1/2			5/8			3/4
Anchor category	1, 2 or 3	-	1		1			1			1			1
Minimum nominal embedment depth	$h_{nom}$	in. (mm)	1-5/8 (41)	2-1/2 (64)	2 (51)	2-1/2 (64)	3-1/4 (83)	2-1/2 (64)	3 (76)	4-1/4 (108)	3-1/4 (64)	4 (64)	5 (127)	4-1/4 (108)
Effective embedment	$h_{ef}$	in. (mm)	1.20 (30)	1.94 (49)	1.33 (34)	1.75 (44)	2.39 (61)	1.75 (44)	2.17 (55)	3.23 (82)	2.24 (57)	2.88 (73)	3.73 (95)	3.08 (78)
<b>Steel Strength in Shear (ACI 318-19 17.7.1, ACI 318-14 17.5.1 or ACI 318-11 D.6.1)</b>														
Steel strength in shear <sup>5</sup>	$V_{sa}$	lb (kN)	1,635 (7.3)	2,040 (9.1)	3,465 (15.4)	3,465 (15.4)	4,345 (19.3)	8,860 (39.4)	8,860 (39.4)	11,175 (49.7)	12,310 (54.8)	12,310 (54.8)	15,585 (69.3)	19,260 (85.7)
Reduction factor for steel strength <sup>3,4</sup>	$\phi$	-							0.60					
<b>Steel Strength in Shear for Seismic Applications (ACI 318-19 17.10.1, ACI 318-14 17.2.3.3 or ACI 318-11 D.3.3.3)</b>														
Steel strength in shear, seismic <sup>6</sup>	$V_{eq}$	lb (kN)	1,360 (6.1)	1,700 (7.7)	2,415 (10.9)	2,415 (10.9)	3,030 (13.6)	7,090 (31.9)	7,090 (31.9)	8,940 (40.2)	9,845 (44.3)	9,845 (44.3)	12,465 (56.1)	15,405 (69.3)
Reduction factor for steel strength in shear for seismic <sup>3,4</sup>	$\phi$	-							0.60					
<b>Concrete Breakout Strength in Shear (ACI 318-19 17.7.2, ACI 318-14 17.5.2 or ACI 318-11 D.6.2)</b>														
Nominal anchor diameter	$d_a$	in. (mm)	0.250 (6.4)		0.375 (9.5)			0.500 (12.7)			0.625 (15.9)			0.750 (19.1)
Load bearing length of anchor	$\ell_e$	in. (mm)	1.20 (30)	1.94 (49)	1.33 (34)	1.75 (44)	2.39 (61)	1.75 (44)	2.17 (55)	3.23 (82)	2.24 (57)	2.88 (73)	3.73 (95)	3.08 (78)
Reduction factor for concrete breakout <sup>3</sup>	$\phi$	-							0.70 (Condition B)					
<b>Pryout Strength in Shear (ACI 318-19 17.7.3, ACI 318-14 17.5.3 or ACI 318-11 D.6.3)</b>														
Coefficient for pryout strength	$k_{cp}$	-	1	1	1	1	1	1	1	2	1	2	2	2
Reduction factor for pryout strength <sup>3</sup>	$\phi$	-							0.70 (Condition B)					

For SI: 1 inch = 25.4 mm; 1 ksi = 6.894 N/mm<sup>2</sup>; 1 ft-lb = 1.356 N-m; 1 lb = 0.0044 kN.

- The data in this table is intended to be used with the design provisions of ACI 318 (-19 or -14) Chapter 17 or ACI 318-11 Appendix D, as applicable; for anchors resisting seismic load combinations the additional requirements of ACI 318-19 17.10, ACI 318-14 17.2.3 or ACI 318-11 D.3.3, as applicable shall apply.
- Installation must comply with published instructions and details.
- All values of  $\phi$  were determined from the load combinations of IBC Section 1605.2, ACI 318 (-19 or -14) Section 5.3, or ACI 318-11 Section 9.2. If the load combinations of ACI 318-11 Appendix C are used, the appropriate value of  $\phi$  must be determined in accordance with ACI 318-11 Section D.4.4. For reinforcement that complies with ACI 318 (-19 or -14) Chapter 17 or ACI 318-11 Appendix D requirements for Condition A, see ACI 318-19 17.5.3, ACI 318-14 17.3.3(c) or ACI 318-11 D.4.3(c), as applicable, for the appropriate  $\phi$  factor when the load combinations of IBC Section 1605.2, ACI 318 (-19 or -14) Section 5.3, or ACI 318-11 Section 9.2 are used.
- The anchors are considered a brittle steel elements as defined by ACI 318-14 2.3 or ACI 318-11 D.1.
- Reported values for steel strength in shear are based on test results per ACI 355.2, Section 9.4 and must be used for design in lieu of the calculated results using equation 17.7.1.2b of ACI 318-19 or equation 17.5.1.2(b) of ACI 318-14 or equation D-29 in ACI 318-11 D.6.1.2.
- Reported values for steel strength in shear are for seismic applications and based on test results in accordance with ACI 355.2, Section 9.6 and must be used for design.
- Anchors are permitted in the topside of concrete-filled steel deck assemblies in accordance with the Installation Detail for Anchors in the Top of Concrete Over Steel Deck Floor and Roof Assemblies with Minimum Topping Thickness.
- Anchors are permitted to be used in lightweight concrete in provided the modification factor  $\lambda_a$  equal to  $0.8\lambda$  is applied to all values of  $f'_c$  affecting  $N_n$ .

**Tension and Shear Design Information for Screw-Bolt+ Anchor in the Soffit (Through the Underside) of Concrete-Filled Steel Deck Assemblies**<sup>1,2,3,4,5,6</sup>

**CODE LISTED**  
ICC-ES ESR-3889



Anchor Property/Setting Information	Notation	Units	Nominal Anchor Diameter (inch)											
			1/4		3/8			1/2			5/8			3/4
Minimum nominal embedment depth	$h_{nom}$	in. (mm)	1-5/8 (41)	2-1/2 (64)	2 (51)	2-1/2 (64)	3-1/4 (83)	2-1/2 (64)	3 (76)	4-1/4 (108)	3-1/4 (84)	4 (64)	5 (127)	4-1/4 (108)
Effective Embedment	$h_{ef}$	in. (mm)	1.20 (30)	1.94 (49)	1.33 (34)	1.75 (44)	2.39 (61)	1.75 (44)	2.17 (55)	3.23 (82)	2.24 (57)	2.88 (73)	3.73 (95)	3.08 (78)
Minimum hole depth	$h_o$	in. (mm)	1-3/4 (44)	2-5/8 (67)	2-1/8 (54)	2-5/8 (67)	3-3/8 (86)	2-5/8 (67)	3-1/8 (79)	4-3/8 (111)	3-3/8 (86)	4-1/8 (10.5)	5-1/8 (130)	4-3/8 (111)
<b>Anchors Installed Through the Soffit of Steel Deck Assemblies into Concrete (Minimum 3-7/8-inch-wide deck flute)</b>														
Minimum concrete member thickness <sup>7</sup>	$h_{min,deck,total}$	in. (mm)	5-1/2 (140)	5-1/2 (140)	5-1/2 (140)	5-1/2 (140)	5-1/2 (140)	5-1/2 (140)	5-1/2 (140)	5-1/2 (140)	5-1/2 (140)	5-1/2 (140)	6-1/4 (159)	6-1/4 (159)
Characteristic pullout strength, uncracked concrete over steel deck, (3,000 psi)	$N_{p,deck,uncr}$	lb (kN)	1,430 (6.4)	2,555 (11.4)	2,275 (10.1)	2,655 (11.8)	3,235 (14.4)	2,600 (11.6)	3,555 (15.8)	5,975 (26.6)	2,610 (11.6)	4,150 (18.5)	6,195 (27.6)	6,085 (27.1)
Characteristic pullout strength, cracked concrete over steel deck, (3,000 psi)	$N_{p,deck,cr}$	lb (kN)	615 (2.7)	1,115 (5.0)	1,290 (5.7)	1,880 (8.4)	2,290 (10.2)	1,230 (5.5)	2,330 (10.4)	4,030 (17.9)	1,600 (7.1)	3,340 (14.9)	4,945 (22.0)	3,835 (17.1)
Characteristic pullout strength, cracked concrete over steel deck, seismic, (3,000 psi)	$N_{p,deck,eq}$	lb (kN)	290 (1.3)	920 (4.1)	890 (4.0)	1,570 (7.0)	2,015 (9.0)	1,230 (5.5)	2,330 (10.4)	4,030 (17.9)	990 (4.4)	1,730 (7.7)	2,415 (10.7)	3,410 (15.2)
Reduction factor for pullout strength <sup>8</sup>	$\phi$	-	0.65											
Steel strength in shear, concrete over steel deck	$V_{sa,deck}$	lb (kN)	1,155 (5.1)	2,595 (11.5)	2,470 (11.0)	2,470 (11.0)	3,225 (14.3)	2,435 (10.8)	2,435 (10.8)	5,845 (26.0)	2,650 (11.8)	2,650 (11.8)	6,325 (28.1)	5,175 (23.0)
Steel strength in shear, concrete over steel deck, seismic	$V_{sa,deck,eq}$	lb (kN)	960 (4.3)	2,165 (9.6)	1,725 (7.7)	1,900 (8.5)	2,250 (10.0)	1,950 (8.7)	2,095 (9.3)	4,675 (20.8)	2,120 (9.4)	2,325 (10.3)	5,060 (22.5)	4,140 (18.4)
Reduction factor for steel strength in shear for concrete over steel deck <sup>8</sup>	$\phi$	-	0.60											
<b>Anchors Installed Through the Soffit of Steel Deck Assemblies into Concrete (Minimum 1-3/4-inch-wide deck flute)</b>														
Minimum concrete member thickness <sup>7</sup>	$h_{min,deck,total}$	in. (mm)	4 (102)	4 (102)	4 (102)	4 (102)	4 (102)	4 (102)	N/A	N/A	N/A	N/A	N/A	N/A
Characteristic pullout strength, uncracked concrete over steel deck, (3,000 psi)	$N_{p,deck,uncr}$	lb (kN)	1,760 (7.8)	2,075 (9.2)	1,440 (6.4)	2,135 (9.5)	3,190 (14.2)	1,720 (7.7)	N/A	N/A	N/A	N/A	N/A	N/A
Characteristic pullout strength, cracked concrete over steel deck, (3,000 psi)	$N_{p,deck,cr}$	lb (kN)	760 (3.4)	910 (4.0)	815 (3.6)	1,510 (6.7)	2,260 (10.1)	1,280 (5.7)	N/A	N/A	N/A	N/A	N/A	N/A
Characteristic pullout strength, cracked concrete over steel deck, seismic, (3,000 psi)	$N_{p,deck,eq}$	lb (kN)	355 (1.6)	750 (3.3)	565 (2.5)	1,260 (5.6)	1,985 (8.8)	1,280 (5.7)	N/A	N/A	N/A	N/A	N/A	N/A
Reduction factor for pullout strength <sup>8</sup>	$\phi$	-	0.65											
Steel strength in shear, concrete over steel deck	$V_{sa,deck}$	lb (kN)	1,880 (8.4)	2,315 (10.3)	2,115 (9.4)	2,115 (9.4)	2,820 (12.5)	2,095 (9.3)	N/A	N/A	N/A	N/A	N/A	N/A
Steel strength in shear, concrete over steel deck, seismic	$V_{sa,deck,eq}$	lb (kN)	1,565 (7.0)	1,930 (8.6)	1,475 (6.6)	1,625 (7.2)	1,965 (8.7)	1,675 (7.5)	N/A	N/A	N/A	N/A	N/A	N/A
Reduction factor for steel strength in shear for concrete over steel deck <sup>8</sup>	$\phi$	-	0.60		0.60			0.60	N/A	N/A	N/A	N/A	N/A	N/A

For Sl: 1 inch = 25.4 mm; 1 ksi = 6.894 N/mm<sup>2</sup>; 1 ft-lb = 1.356 N-m; 1 lb = 0.0044 kN.

- Installation must comply with published instructions and details.
- Values for  $N_{p,deck}$  and  $N_{p,deck,cr}$  are for sand-lightweight concrete ( $f'_c$ , min = 3,000 psi) and additional lightweight concrete reduction factors need not be applied. In addition, evaluation for the concrete breakout capacity in accordance with ACI 318-19 17.6.2, ACI 318-14 17.4.2 or ACI 318 D.5.2, as applicable, is not required for anchors installed in the deck soffit (through underside).
- Values for  $N_{p,deck,eq}$  are applicable for seismic loading and must be used in lieu of  $N_{p,deck,cr}$ .
- For all design cases  $\Psi_{c,p} = 1.0$ . The characteristic pullout strength,  $N_{p,n}$ , for concrete compressive strengths greater than 3,000 psi for 1/4-inch-diameter anchors may be increased by multiplying the value in the table by  $(f'_c / 3,000)^{0.5}$  for psi or  $(f'_c / 17.2)^{0.5}$  for MPa. The characteristic pullout strength,  $N_{p,n}$ , for concrete compressive strengths greater than 3,000 psi for 3/8-inch- to 3/4-inch-diameter anchors may be increased by multiplying the value in the table by  $(f'_c / 3,000)^{0.5}$  for psi or  $(f'_c / 17.2)^{0.5}$  for MPa.
- Shear loads for anchors installed through steel deck into concrete may be applied in any direction.
- Values of  $V_{sa,deck}$  and  $V_{sa,deck,eq}$  are for sand-lightweight concrete and additional lightweight concrete reduction factors need not be applied. In addition, evaluation for the concrete breakout capacity in accordance with ACI 318-19 17.7.2, ACI 318-14 17.5.2 or ACI 318-11 D.6.2, as applicable, and the pryout capacity in accordance with ACI 318-19 17.7.3, ACI 318-14 17.5.3 or ACI 318-11 D.6.3, as applicable, are not required for anchors installed in the soffit (through underside).
- The minimum concrete member thickness,  $h_{min,deck,total}$ , is the minimum overall thickness of the concrete-filled steel deck (depth and topping thickness).
- All values of  $\phi$  were determined from the load combinations of 2021 IBC Section 1605.1 or 2018, 2015 and 2012 IBC 1605.2, ACI 318 (-19 or -14) Section 5.3 or ACI 318 Section 9.2. If the load combinations of ACI 318-11 Appendix C are used, then the appropriate value of  $\phi$  must be determined in accordance with ACI 318-11 D.4.4.

**MECHANICAL ANCHORS**  
**SCREW-BOLT+**<sup>TM</sup>  
High Performance Screw Anchor

TECHNICAL GUIDE – MECHANICAL ANCHORS ©2023 DEWALT – REV G

**DESIGN STRENGTH TABLES (SD)**



**Tension and Shear Design Strength Installed in Cracked Concrete**<sup>1,2,3,4,5,6,7</sup>

Nominal Anchor Diameter (in.)	Nominal Embed. Depth $h_{nom}$ (in.)	Minimum Concrete Compressive Strength									
		$f'c = 2,500$ psi		$f'c = 3,000$ psi		$f'c = 4,000$ psi		$f'c = 6,000$ psi		$f'c = 8,000$ psi	
		$\phi N_n$ Tension (lbs.)	$\phi V_n$ Shear (lbs.)	$\phi N_n$ Tension (lbs.)	$\phi V_n$ Shear (lbs.)	$\phi N_n$ Tension (lbs.)	$\phi V_n$ Shear (lbs.)	$\phi N_n$ Tension (lbs.)	$\phi V_n$ Shear (lbs.)	$\phi N_n$ Tension (lbs.)	$\phi V_n$ Shear (lbs.)
1/4	1-5/8	495	780	525	855	575	980	645	980	705	980
	2-1/2	920	1,225	970	1,225	1,060	1,225	1,195	1,225	1,305	1,225
3/8	2	845	915	930	1,000	1,070	1,155	1,315	1,415	1,515	1,635
	2-1/2	1,280	1,375	1,400	1,510	1,620	1,740	1,980	2,080	2,290	2,080
	3-1/4	2,040	2,200	2,235	2,410	2,580	2,605	3,165	2,605	3,650	2,605
1/2	2-1/2	1,070	1,335	1,170	1,460	1,355	1,690	1,655	2,065	1,915	2,385
	3	1,635	1,900	1,790	2,085	2,070	2,405	2,535	2,945	2,925	3,400
	4-1/4	3,055	5,295	3,345	5,800	3,865	6,695	4,735	6,705	5,465	6,705
5/8	3-1/4	1,850	1,995	2,030	2,185	2,345	2,525	2,870	3,090	3,315	3,570
	4	2,700	5,090	2,960	5,575	3,415	6,435	4,185	7,385	4,830	7,385
	5	3,980	7,400	4,360	8,105	5,035	9,350	6,165	9,350	7,120	9,350
3/4	4-1/4	2,985	6,430	3,270	7,045	3,780	8,135	4,625	9,965	5,340	11,505

□ - Anchor Pullout/Pryout Strength Controls 
 □ - Concrete Breakout Strength Controls 
 ■ - Steel Strength Controls

**Tension and Shear Design Strength Installed in Uncracked Concrete**<sup>1,2,3,4,5,6</sup>

Nominal Anchor Diameter (in.)	Nominal Embed. Depth $h_{nom}$ (in.)	Minimum Concrete Compressive Strength									
		$f'c = 2,500$ psi		$f'c = 3,000$ psi		$f'c = 4,000$ psi		$f'c = 6,000$ psi		$f'c = 8,000$ psi	
		$\phi N_n$ Tension (lbs.)	$\phi V_n$ Shear (lbs.)	$\phi N_n$ Tension (lbs.)	$\phi V_n$ Shear (lbs.)	$\phi N_n$ Tension (lbs.)	$\phi V_n$ Shear (lbs.)	$\phi N_n$ Tension (lbs.)	$\phi V_n$ Shear (lbs.)	$\phi N_n$ Tension (lbs.)	$\phi V_n$ Shear (lbs.)
1/4	1-5/8	1,155	980	1,265	980	1,460	980	1,785	980	2,065	980
	2-1/2	2,110	1,225	2,310	1,225	2,665	1,225	2,950	1,225	2,950	1,225
3/8	2	1,495	1,610	1,640	1,765	1,890	2,035	2,315	2,080	2,675	2,080
	2-1/2	1,805	1,945	1,980	2,080	2,285	2,080	2,795	2,080	3,230	2,080
	3-1/4	2,880	2,605	3,155	2,605	3,645	2,605	4,465	2,605	5,155	2,605
1/2	2-1/2	2,255	1,870	2,475	2,045	2,855	2,365	3,495	2,895	4,040	3,340
	3	2,495	2,685	2,730	2,940	3,155	3,395	3,865	4,160	4,460	4,805
	4-1/4	4,530	6,705	4,960	6,705	5,725	6,705	7,015	6,705	8,100	6,705
5/8	3-1/4	3,270	3,520	3,580	3,855	4,135	4,455	5,065	5,455	5,845	6,295
	4	3,810	7,125	4,175	7,385	4,820	7,385	5,905	7,385	6,820	7,385
	5	5,620	9,350	6,155	9,350	7,110	9,350	8,705	9,350	10,050	9,350
3/4	4-1/4	4,745	10,215	5,195	11,190	6,000	11,555	7,350	11,555	8,485	11,555

□ - Anchor Pullout/Pryout Strength Controls 
 □ - Concrete Breakout Strength Controls 
 ■ - Steel Strength Controls

- Tabular values are provided for illustration and are applicable for single anchors installed in normal-weight concrete with minimum slab thickness,  $h_a = 1.5h_{min}$ , and with the following conditions:
  - $C_{a1}$  is greater than or equal to the critical edge distance,  $C_{ac}$  (table values based on  $C_{a1} = C_{ac}$ ).
  - $C_{a2}$  is greater than or equal to 1.5 times  $C_{a1}$ .
- Calculations were performed according to ACI 318-19, Chapter 17. The load level corresponding to the controlling failure mode is listed. (e.g. For tension: steel, concrete breakout and pullout; For shear: steel, concrete breakout and pryout). Furthermore, the capacities for concrete breakout strength in tension and pryout strength in shear are calculated using the effective embedment values,  $h_{ef}$ , for the selected anchors as noted in the design information tables. Please also reference the installation specifications for more information.
- Strength reduction factors ( $\phi$ ) were based on ACI 318-19 Section 5.3 for load combinations. Condition B is assumed.
- Tabular values are permitted for static loads only, seismic loading is not considered with these tables.
- For designs that include combined tension and shear, the interaction of tension and shear loads must be calculated in accordance with ACI 318-19, Chapter 17.
- Interpolation is not permitted to be used with the tabular values. For intermediate base material compressive strengths please see ACI 318-19, Chapter 17. For other design conditions including seismic considerations please see ACI 318-19, Chapter 17.
- For seismic design of anchors installed in regions designated as Seismic Design Categories C, D, E or F and in accordance with ACI 318, the tabulated tension design strengths in cracked concrete for concrete breakout and pullout must be multiplied by a factor of 0.75.

**MECHANICAL ANCHORS**

**SCREW-BOLT+™**  
High Performance Screw Anchor





**Tension and Shear Design Strength at Minimum Edge Distance,  $c_{min}$  for Screw-Bolt+ in Cracked Concrete**<sup>1,2,3,4,5,6,7</sup>

Nominal Anchor Diameter (in.)	Nominal Embed. $h_{nom}$ (in.)	Minimum Concrete Compressive Strength									
		$f'_c = 2,500$ psi		$f'_c = 3,000$ psi		$f'_c = 4,000$ psi		$f'_c = 6,000$ psi		$f'_c = 8,000$ psi	
		$\phi N_n$ Tension (lbs.)	$\phi V_{sn}$ Shear (lbs.)	$\phi N_n$ Tension (lbs.)	$\phi V_{sn}$ Shear (lbs.)	$\phi N_n$ Tension (lbs.)	$\phi V_{sn}$ Shear (lbs.)	$\phi N_n$ Tension (lbs.)	$\phi V_{sn}$ Shear (lbs.)	$\phi N_n$ Tension (lbs.)	$\phi V_{sn}$ Shear (lbs.)
1/4	1-5/8	495	310	525	335	575	390	645	475	705	550
	2-1/2	920	340	970	370	1,060	430	1,195	525	1,305	605
3/8	2	685	355	755	390	870	450	1,065	550	1,230	635
	2-1/2	875	375	960	410	1,110	475	1,355	580	1,565	670
	3-1/4	1,195	400	1,310	435	1,510	505	1,850	620	2,140	715
1/2	2-1/2	960	515	1,050	565	1,215	650	1,485	800	1,715	920
	3	1,170	540	1,280	590	1,480	680	1,810	835	2,090	960
	4-1/4	1,765	580	1,935	640	2,230	735	2,735	900	3,155	1,040
5/8	3-1/4	1,205	580	1,320	635	1,525	730	1,870	895	2,155	1,035
	4	1,560	610	1,705	665	1,970	770	2,415	945	2,790	1,090
	5	2,075	640	2,270	700	2,625	810	3,215	995	3,710	1,145
3/4	4-1/4	1,675	650	1,835	715	2,120	825	2,595	1,010	2,995	1,165

■ - Anchor Pullout/Pryout Strength Controls ■ - Concrete Breakout Strength Controls ■ - Steel Strength Controls

**Tension and Shear Design Strength at Minimum Edge Distance,  $c_{min}$  for Screw-Bolt+ in Uncracked Concrete**<sup>1,2,3,4,5,6</sup>

Nominal Anchor Diameter (in.)	Nominal Embed. $h_{nom}$ (in.)	Minimum Concrete Compressive Strength									
		$f'_c = 2,500$ psi		$f'_c = 3,000$ psi		$f'_c = 4,000$ psi		$f'_c = 6,000$ psi		$f'_c = 8,000$ psi	
		$\phi N_n$ Tension (lbs.)	$\phi V_{sn}$ Shear (lbs.)	$\phi N_n$ Tension (lbs.)	$\phi V_{sn}$ Shear (lbs.)	$\phi N_n$ Tension (lbs.)	$\phi V_{sn}$ Shear (lbs.)	$\phi N_n$ Tension (lbs.)	$\phi V_{sn}$ Shear (lbs.)	$\phi N_n$ Tension (lbs.)	$\phi V_{sn}$ Shear (lbs.)
1/4	1-5/8	420	430	460	470	530	545	650	670	750	770
	2-1/2	650	475	715	520	825	600	1,010	735	1,165	850
3/8	2	485	495	530	545	610	630	750	770	865	890
	2-1/2	515	525	565	575	650	665	800	815	920	940
	3-1/4	775	560	850	610	980	705	1,200	865	1,385	1,000
1/2	2-1/2	1,345	720	1,475	790	1,705	910	2,085	1,120	2,410	1,290
	3	910	755	1,000	825	1,150	955	1,410	1,165	1,630	1,345
	4-1/4	1,490	815	1,630	895	1,885	1,030	2,310	1,265	2,665	1,460
5/8	3-1/4	1,135	810	1,245	890	1,435	1,025	1,760	1,255	2,030	1,450
	4	1,205	850	1,320	935	1,520	1,080	1,865	1,320	2,150	1,525
	5	1,620	895	1,775	985	2,050	1,135	2,515	1,390	2,900	1,605
3/4	4-1/4	1,130	910	1,235	1,000	1,425	1,155	1,745	1,415	2,015	1,630

■ - Anchor Pullout/Pryout Strength Controls ■ - Concrete Breakout Strength Controls ■ - Steel Strength Controls

- Tabular values are provided for illustration and are applicable for single anchors installed in normal-weight concrete with minimum slab thickness,  $h_a = h_{min}$ , and with the following conditions:
  - $c_{a1}$  is greater than or equal to the minimum edge distance,  $c_{min}$  (table values based on  $c_{a1} = C_{min}$ ).
  - $c_{a2}$  is greater than or equal to 1.5 times  $c_{a1}$ .
- Calculations were performed according to ACI 318-19, Chapter 17. The load level corresponding to the controlling failure mode is listed. (e.g. For tension: steel, concrete breakout and pullout; For shear: steel, concrete breakout and pryout). Furthermore, the capacities for concrete breakout strength in tension and pryout strength in shear are calculated using the effective embedment values,  $h_{ef}$ , for the selected anchors as noted in the design information tables. Please also reference the installation specifications for more information.
- Strength reduction factors ( $\phi$ ) were based on ACI 318-19 Section 5.3 for load combinations. Condition B is assumed.
- Tabular values are permitted for static loads only, seismic loading is not considered with these tables.
- For designs that include combined tension and shear, the interaction of tension and shear loads must be calculated in accordance with ACI 318-19, Chapter 17.
- Interpolation is not permitted to be used with the tabular values. For intermediate base material compressive strengths please see ACI 318-19, Chapter 17. For other design conditions including seismic considerations please see ACI 318-19, Chapter 17.
- For seismic design of anchors installed in regions designated as Seismic Design Categories C, D, E or F and in accordance with ACI 318, the tabulated tension design strengths in cracked concrete for concrete breakout and pullout must be multiplied by a factor of 0.75.

**MECHANICAL ANCHORS**

**SCREW-BOLT+™**  
High Performance Screw Anchor

**ORDERING INFORMATION**



**Screw-Bolt+**

Cat. No.			Anchor Size	Approximate Thread Length	Box Qty.	Ctn. Qty.	20V Max* SDS Plus Rotary Hammers			Flexvolt SDS Max
							DCH273P2DH 1" L-Shape	DCH133M2 1" D-Handle	DCH293R2 1-1/8" L-Shape w/ E-Clutch	DCH481X2 1-9/16" w/ E-Clutch
Hex Head		Flat Head	Carbide Bits							
Zinc Plated	Galvanized	Zinc Plated								
PFM1411000	-	-	1/4" x 1-1/4"	1-1/4"	100	600	DW5517	DW5417	DW5417	-
PFM1411020	-	-	1/4" x 1-3/4"	1-5/8"	100	600	DW5517	DW5417	DW5417	-
PFM1411060	-	-	1/4" x 2-1/4"	1-5/8"	100	600	DW5517	DW5417	DW5417	-
PFM1411080	-	-	1/4" x 2-5/8"	2-1/2"	100	500	DW5517	DW5417	DW5417	-
PFM1411100	-	PFM1411105	1/4" x 3"	2-1/2"	100	500	DW5517	DW5417	DW5417	-
PFM1411160	-	-	3/8" x 1-3/4"	1-3/4"	50	300	DW5527	DW5427	DW5427	-
PFM1411220	-	PFM1411225	3/8" x 2-1/2"	2"	50	300	DW5527	DW5427	DW5427	-
PFM1411240	PFM1461240	PFM1411245	3/8" x 3"	2"	50	250	DW5527	DW5427	DW5427	-
PFM1411280	PFM1461280	PFM1411285	3/8" x 4"	3-1/4"	50	250	DW5527	DW5427	DW5427	-
PFM1411300	PFM1461300	-	3/8" x 5"	3-1/4"	50	250	DW5529	DW5429	DW5429	-
PFM1411320	PFM1461320	-	3/8" x 6"	3-1/4"	50	150	DW5529	DW5429	DW5429	-
PFM1411340	-	-	1/2" x 2"	1-3/4"	50	200	DW5537	DW5437	DW5437	-
PFM1411360*	-	-	1/2" x 2-1/2"	2-1/2"	50	200	DW5537	DW5437	DW5437	-
PFM1411380	-	PFM1411385	1/2" x 3"	2-1/2"	50	150	DW5537	DW5437	DW5437	-
PFM1411420	PFM1461420	PFM1411425	1/2" x 4"	2-1/2"	50	150	DW5537	DW5437	DW5437	-
PFM1411460	PFM1461460	PFM1411465	1/2" x 5"	4-1/4"	25	100	DW5538	DW5438	DW5438	-
PFM1411480	PFM1461480	-	1/2" x 6"	4-1/4"	25	75	DW5538	DW5438	DW5438	-
PFM1411520	PFM1461520	-	1/2" x 8"	4-1/4"	25	100	DW5538	DW5438	DW5438	-
PFM1411540	-	-	5/8" x 3"	2-3/4"	25	100	DW5471	DW5446	DW5471	DW5806
PFM1411580	-	-	5/8" x 4"	3-1/4"	25	100	DW5471	DW5446	DW5471	DW5806
PFM1411600	PFM1461600	-	5/8" x 5"	5"	25	75	DW5471	DW5446	DW5471	DW5806
PFM1411640	PFM1461640	-	5/8" x 6"	5"	25	75	DW5471	DW5446	DW5471	DW5806
PFM1411680	PFM1461680	-	5/8" x 8"	5"	25	50	DW5471	DW5447	DW5471	DW5806
PFM1411700	-	-	3/4" x 3"	3"	20	60	DW5474	DW5453	DW5474	DW5810
PFM1411720	-	-	3/4" x 4"	3"	20	60	DW5474	DW5453	DW5474	DW5810
PFM1411760	-	-	3/4" x 5"	4-1/4"	20	60	DW5474	DW5453	DW5474	DW5810
PFM1411800	PFM1461800	-	3/4" x 6"	4-1/4"	20	60	DW5474	DW5453	DW5474	DW5810
PFM1411840	PFM1461850	-	3/4" x 8"	4-1/4"	10	40	DW5474	DW5455	DW5474	DW5810
PFM1411880	-	-	3/4" x 10"	4-1/4"	10	20	DW5475	DW5455	DW5475	DW5812

Shaded catalog numbers denote sizes which are less than the minimum standard anchor length for Strength Design. Anchors not long enough to meet the minimum nominal embedments published for strength design are outside the scope of ICC-ES ESR-3889.

Catalog numbers with an asterisk (\*) denote sizes that meet the minimum anchor length requirement for strength design provided the fixture attachment does not exceed 0.036-inch (0.91mm) in thickness.

The selected anchor length should be long enough to accommodate the attachment thickness and achieve the minimum nominal embedment into the base material required for the application.

The published size includes the nominal diameter and length of the anchor. The length is measured from under the head for hex head parts and from the top of the head for flat head (countersunk) parts.

- Optimum Tool Match
- Maximum Tool Match
- Not Recommended

**MECHANICAL ANCHORS**

**SCREW-BOLT+™**  
High Performance Screw Anchor

**Impact Wrench Selection Guide**

Anchor Setting Information	Nominal Anchor Diameter (Inch)									
	1/4"		3/8"		1/2"		5/8"		3/4"	
Max Impact Wrench Power	150 ft-lbs		300 ft-lbs		300 ft-lbs		700 ft-lbs		700 ft-lbs	
Suggested 20V Max Impact Wrench, Tool Setting / Speed and Cat. No.	FULL	SPEED 1	SPEED 1	SPEED 2	SPEED 1	SPEED 2	SPEED 2	SPEED 3	SPEED 2	SPEED 3
	DCF902	DCF921, DCF922, DCF923, DCF891, DCF892, DCF900	DCF911, DCF913, DCF900	DCF921, DCF922, DCF923, DCF891, DCF892	DCF911, DCF913, DCF900	DCF921, DCF922, DCF923, DCF891, DCF892	DCF900	DCF891, DCF892	DCF900	DCF891, DCF892

**DEWALT Impact Wrenches**



Cat. No.	DCF901	DCF903	DCF911	DCF913	DCF921	DCF922	DCF923	DCF891	DCF892
Anvil Size	3/8"	1/2"	3/8"	1/2"	1/2"	3/8"	1/2"	1/2"	1/2"
Anvil Type	Hog Ring	Hog Ring	Hog Ring	Hog Ring	Hog Ring	Detent	Hog Ring	Hog Ring	Detent
MAX Fastening Torque	Speed 1: 250 ft-lbs	Speed 1: 250 ft-lbs	Speed 1: 250 ft-lbs	Speed 1: 250 ft-lbs	Speed 1: 100 ft-lbs Speed 2: 300 ft-lbs	Speed 1: 100 ft-lbs Speed 2: 300 ft-lbs	Speed 1: 100 ft-lbs Speed 2: 300 ft-lbs	Speed 1: 100 ft-lbs Speed 2: 300 ft-lbs Speed 3: 600 ft-lbs	Speed 1: 100 ft-lbs Speed 2: 300 ft-lbs Speed 3: 600 ft-lbs

**MECHANICAL ANCHORS**

**SCREW-BOLT+™**  
High Performance Screw Anchor